



THE  
**SPRAY NOZZLE**  
PEOPLE

# Cleaning & Disinfecting

**Brochure**

## 1- Cleaning and wash down (spray)

- Wash down guns
- Wash down mixing stations
- Air powered mobile cleaning stations
- Conveyor cleaning
- Manual sprayers
- Cleaning nozzles

## 2- Fogging and misting

- Compressed air fogging guns
- Fogging nozzles
- Motorised foggers
- Electric foggers
- Compressed air fogging stations
- Mobile compressed air fogging
- Complete fogging systems

## 3- Foaming

- Compressed air foam guns
- Airless foam guns
- Foam mixing stations
- Mobile foaming stations

## 4- Tank cleaning

- Rotary jet cleaners
- Spray balls
- Spinners
- Specialist vessels

## CLEANING & DISINFECTION EQUIPMENT BROCHURE

Cleaning and disinfection in manufacturing and industrial settings is of paramount importance. This is particularly true in certain industries such as food processing, dairy and pharmaceuticals. In these high-use industries a poor cleaning regime can literally result in the closure of the business by standards agencies.

With the arrival of the coronavirus, effective equipment to assist in cleaning and disinfection has become important not just for the industries above, however, but for virtually every other sector of the economy. In addition, in a bid to combat the spread of the virus, we are fast having to become familiar with types of equipment we previously had little or no use for such as disinfectant fogging machines.

This brochure contains a range of equipment to not only meet the highest standards of cleaning and disinfection but also to help reduce water/chemical usage and the time and manpower required for these operations.

Below we examine what elements are required for effective cleaning and disinfecting operations and how each piece of equipment contributes to these processes.

### CLEANING, DISINFECTION AND SANITISING

Cleaning uses soap or other detergents and water to remove stains, bacteria, dust etc from a surface. This removes some of the virus itself and material that might shield the virus. Cleaning should always be undertaken before disinfecting.

Disinfecting uses disinfectants to kill and reduce viruses or bacteria which may still be on surfaces or in the air. Put in terms of fluid usage, cleaning requires relatively large volumes directed well whereas disinfection requires lower volumes distributed well.

Sanitising is the complete removal of pathogens and so is an extreme form of disinfection. In terms of equipment, however, the fluid distribution for disinfection or sanitising is basically the same so from this perspective they are the same process.



## THE CLEANING MIX - 4 ELEMENTS

Effective cleaning consists of 4 elements: chemical action, time, mechanical action and heat. Each of these elements contributes a certain amount of "cleaning power" in any given tank cleaning operation.

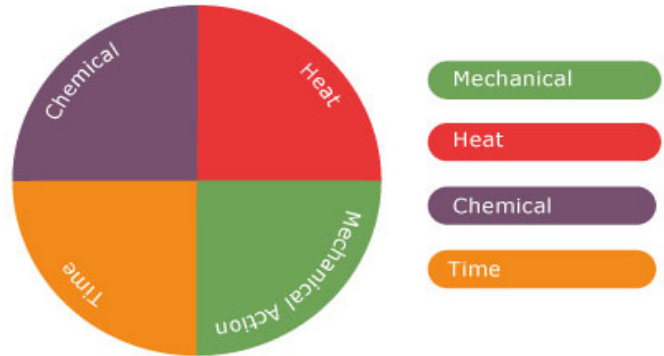

An increase in one element means other elements can be reduced without compromising overall cleaning. Conversely a reduction in any given element must be compensated for by a corresponding increase in one or more of the other elements if cleaning is to be maintained. The relative contributions of each element varies considerably depending on which type of cleaning system is deployed.

- Mechanical action can be increased by using jetting nozzles with higher pressures. This is especially useful in tank cleaning systems
- Heat can be modified by increasing the temperature of the cleaning fluid
- The chemical action component can be increased by the introduction of caustics and disinfectants
- Foams can be used to increase the time component of the mix by ensuring cleaning chemicals stay on the target for longer

## WATER USAGE

Water is the most common solvent used in any cleaning operation so, in this respect, it belongs to the chemical action part of the mix. Also the longer a cleaning operation goes on for (at a given flow rate of water) the more water will be used. Overall water consumption is, therefore, a function of both the time and chemical action elements of the mix. Thus, it follows that water consumption can be reduced by improving mechanical action and the heat elements of the mix. Or by the use of foams which will increase the "time" element without the use of more water.

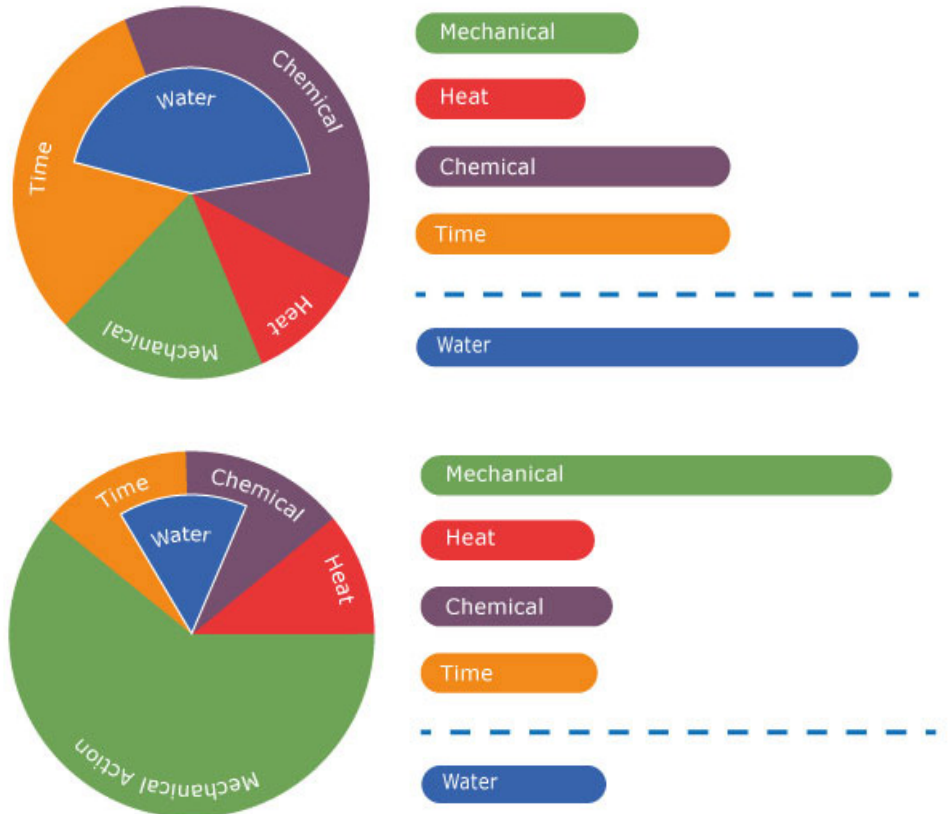

## THE DISINFECTION MIX - 4 ELEMENTS

To be effective, disinfection requires a different mix of elements from those seen in cleaning.

### Surface preparation

The surfaces being treated must first be cleaned. Even small amounts of residue can protect pathogens from disinfectant chemicals meaning the process is not complete.

### Coverage

Disinfectants must be distributed over the entire surface. Patches that are not hit are not disinfected. This can either be achieved by spraying lots of fluid, which is expensive, or by using finer spray with small droplets to help achieve an even fine coating.

### Distribution

As pathogens can lurk in every nook and cranny, disinfectants need to be distributed to every nook and cranny. Often with complex environments this is problematic. Fogging systems can help greatly with this as they allow disinfecting fogs to move around and settle on all surfaces.

### Dosing

The correct dose of chemical must be delivered to the surfaces or air spaces being treated. Normally, disinfectants are mixed with water to form a sanitising solution. Careful consideration needs to be given to how the disinfecting spray/fog is mixed accurately over the whole area. Conversely over dosing will be wasteful or could lead to harmful residues.

- Surface access can be improved by deploying a suitable clean and rinse system prior to disinfection
- Coverage can be improved with the use of fine sprays or wet fog systems that atomise the fluid well
- Distribution can be improved by having suitable spray systems in every part of the space being disinfected that can be directed to the areas needed. Alternatively the use of fogging systems can dramatically increase the distribution element of the sanitising mix
- Dosing can be improved by careful calculation of what is required and by using suitable mixing stations.

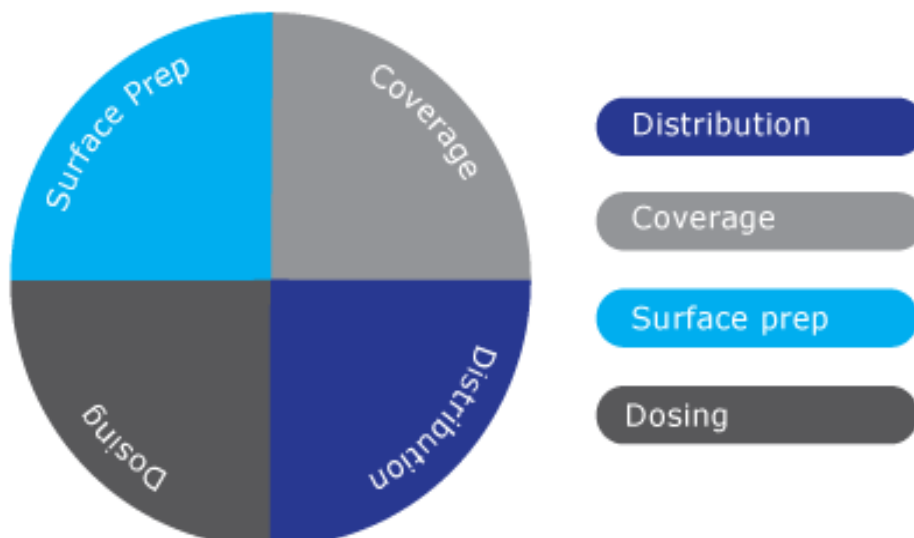

## EQUIPMENT FUNCTIONALITY CHART

The chart below indicates the contribution each piece of equipment in this brochure can make to each of the four core elements of cleaning or disinfection. A "high" contribution is always better than a low one. Where no rating is given, this equipment is deemed not to contribute in a significant way for this element.

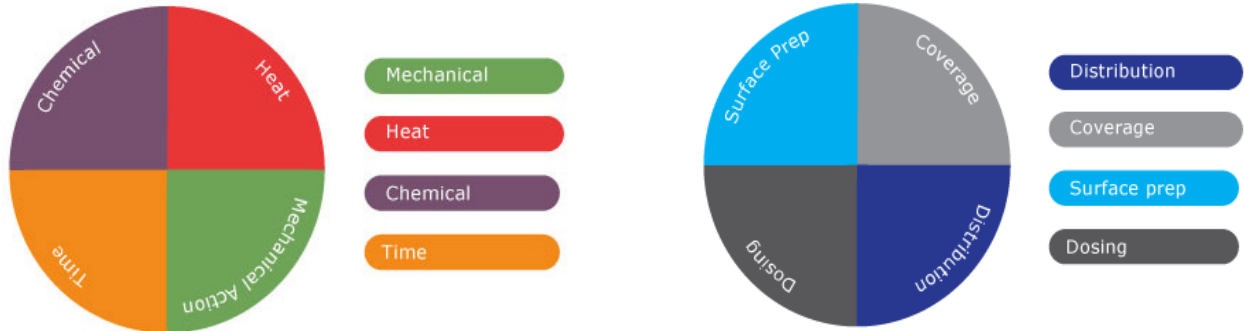

Equipment	Cleaning Operations				Disinfection / Sanitising Operations			
	Heat	Time	Mech	Chem	Surf	Dist	Cove	Dose
Washdown guns		Low	Med	Low	Med		Med	
Mixing Stations				High				High
Air powered mobile		Med	Med	Low	Med	Med	Med	Med
Conveyor cleaning			Med	Low	Med		Med	
Manual sprayers				Med		High	Med	
Nozzles for cleaning		Low	Med	Med	Med	Med	Med	
Air fog guns		Med		Med		High	High	
Fog nozzles		High		High		High	High	
Motorised fogger		High		Med		High	High	Med
Electric fogger		High		High		High	High	
Air fog station		High		High		High		
Mobile air fogger		High		High		High	High	
Fogging systems		High		High		High	High	High
Airless Foaming		Med		Med			High	
Air pump foamers		Med	Low	Med	Low		Med	Med
Air assisted foams		High		High			High	Med
Rotary jet TC		High	High	High	High		Med	
Spinner TC		Med	Med	Med	Low		High	
Spray ball TC		Low	Low	Low	Low		High	
Specialist TC		Var	Var	Var	Var		Var	

## CLEANING AND WASH-DOWN EQUIPMENT

In this section we detail equipment used for the distribution and spraying of cleaning liquids. The process of cleaning needs to be distinguished from that of disinfecting. Cleaning involves the removal of contaminants including greases, fats, proteins and other residues. It is vital to clean surfaces properly before any secondary disinfection or sanitising process can be implemented.

Cleaning will most often involve the use of detergents, caustics and other cleaning chemicals to aid in the breakdown of residues. The equipment in this section is used for the mixing and delivery of liquid cleaning chemicals and water. For processes that involve the generation of foams please consult our foaming section. For processes that involve the generation of fogs for disinfection please see our fogging equipment section.

### Wash down guns

#### Compact sprayers

A simple spray gun with an integrated pot for chemical concentrate. The sprayer will automatically mix the mains water feed with the concentrate to the correct dosage.



#### Wall mounted wash-down

Wash-down guns supplied from a wall mounted unit with venturi chemical pickup system. Mixing occurs at the wall rather than at the gun.



#### Two-way guns

A wall mounted supply system combines chemical concentrate with the mains water supply to deliver a wash down solution at the correct mix. With the flip of switch the system can be turned into a pure water rinse system from the same gun.



#### Features

- Mains, boosted and high pressure water supply options
- Simple and effective concentrate mixing either at the gun or at the wall
- Wide variety of flow rates and gun types available
- Just needs a water supply to work

### Wash down mixing stations

#### Mixing stations

Venturi mixing stations for the mixing of cleaning solutions. These mixing stations can be calibrated to deliver accurate and reliable mixes of chemical concentrates and mains water. They require no power and no pumps meaning they are easy to install and simple to use.



#### Features

- Simple, reliable and accurate
- Ball valve or push lever options
- 1-5 way mixing from one station
- No pumps or power required
- Robust and easy to maintain

## Air powered mobile cleaning stations

### Pressure pot systems

These mobile wash-down units are powered entirely by compressed air. They come in a variety of sizes and are suitable for the distribution of pre-diluted wash-down liquids.



### Air-pump system

As an alternative to the pressure pot systems these mobile units have a compressed air powered diaphragm pump. Like the pressure pot system this only requires compressed air to operate and it allows for the spraying of both pre-diluted or undiluted liquids. The mixing is performed by an integrated venturi system.



### Features

- No external power other than compressed air
- Variety of nozzles for different spray patterns
- Integrated mixing of concentrate (air pump model only)
- Range of sizes to suit any small-medium sized area cleaning

## Conveyor cleaning

### Conveyor sanitiser

This venturi mix system delivers a sanitising spray to conveyors. It can be wall mounted or mounted on portable trolley. Either option only requires connection to a mains water supply at 2.5 bar or above. The mixing of the concentrate is achieved via the venturi process.



### Features

- Only mains water pressure required
- Single lance or double "over and under" options available
- Automatic venturi mixing of concentrate
- Adjustable arms and nozzles to ensure coverage of variable width conveyors





## Manual sprayers

Backpack and compression sprayers will produce wet sprays. The low flow rates and pressures from these units mean they are not really usable for rinse and wash-down (which requires large volumes of fluid) but they are ideal for the spraying of disinfectants and detergent chemicals to areas that may be hard to reach with more conventional wash down systems.



### Features

- Cost effective
- No power needed
- Produce a low impact spray
- Range of models to suit different situations

## Nozzles for cleaning

### High impact fan nozzles

These nozzles are designed to maximise impact. The fluid is deflected from the nozzle's "spoon" shaped surface into a high impact narrow fan pattern. A wide range of flow rates are available making them an excellent choice for many conveyor based cleaning systems.

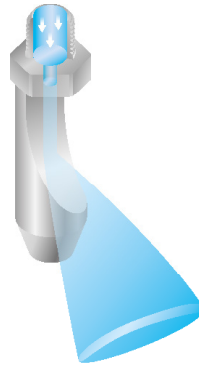

### Features

- Coarse medium-high impact sprays
- Vast range of spray angles and flow rates to suit any cleaning system
- Hygienic materials (316 stainless steel)

### Standard fan nozzle

The humble flat fan nozzle is perhaps the most commonly deployed cleaning nozzle. Its simple design produces a line of medium impact spray making it ideal for conveyor based wash, rinse and cleaning systems.

Flat fan nozzles are available in a huge range of spray angles and flow rates. They are also available in a wide range of materials to suit almost any environment.

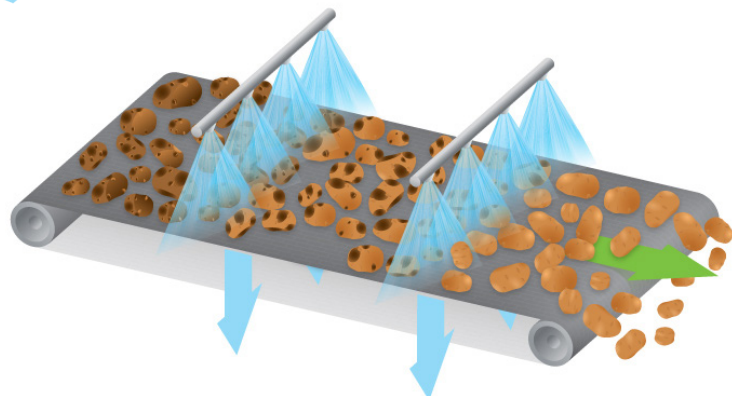

## FOGGING AND MISTING

In this section we detail equipment used for the distribution of fogs and fine mists for disinfection and sanitising. The fogs generated by this equipment are very different in nature to the fluid distributed by our cleaning/wash-down systems and our foaming systems. The objective with any fogging system is to maximise the coverage of the disinfecting chemicals and to ensure they come into contact with as much of the airspace and surfaces being treated as possible. This is best achieved by finely atomised sprays which will remain aerosolised for longer periods of time.

The effective distribution of fogs and mists is a significant problem to overcome. By their very nature fogs do not have a lot of natural momentum (unlike sprays from wash down guns). For this reason the use of compressed air or fan induced air flows is a common feature in our fogging systems. Not only does the fast moving air help atomise the disinfectant it also helps distribute it over a wide area.

### Compressed Air Fogging guns

#### Lafferty Fogging Guns

Lafferty Fogging Guns use compressed air to entrain a low volume of fluid. Flow rates can be controlled by utilizing a number of plastic flow restrictors.



#### Features

- Produces a fog
- Variety of spray patterns
- Can achieve very small drop sizes
- Requires compressed air supply

#### Eva-mist air atomising fog gun

An advanced stainless steel air atomising nozzle that gives a consistent even dry fog. All that is required is a suitable compressed air supply.



#### Features

- Produces a dry mist
- Suitable for use on surfaces including on fabrics and electronics
- Requires compressed air supply

This is also available as a stand alone unit that comes with a quiet compressor and air hose reel. All that is required is a power supply for the compressor.



## Spray / fog nozzles for fogging systems

For purpose built fogging systems we provide a wide range of fogging nozzles. Our extensive range of products combined with decades of experience in designing spraying systems means we can achieve the exact drop size and spray distribution required for your system.

### Air atomising nozzles

These use the energy in compressed air to produce highly atomised sprays at low flow rates. There are many interchangeable components that can be assembled to achieve a variety of spraying objectives for any given system in which they might be used.



#### Features

- Produce finely atomised mist
- Wide range of flow rates and spray patterns
- Help project fogs from the nozzle
- Require compressed air supply
- Siphon fed options require no fluid pump

### High pressure nozzles

There are a variety of misting nozzles which are characterised by their very small droplet size and relatively small flow rate. The pressure of the incoming fluid is used to drive the atomisation process. Higher liquid pressures produce increasingly finer droplets.



#### Features

- No air required
- Best operating between 20-150 bar fluid pressure
- Wide range of flows and drop sizes
- Secondary distribution systems (e.g. fans) required for large area fogging

## Motorised backpack foggers

### Motorised backpack

A powerful motor driven nebuliser that can deliver a wide range of flow rates. The powerful Kawasaki engine can project a fine fog as much as 18 meters horizontally and 12 metres vertically making this an idea tool for the fogging and disinfecting of large warehouses, industrial units or outside areas.



#### Features

- Runs on two stroke petrol
- Adjustable flows between 0.2 and 2.5l/min
- Vertical reach 12 meters
- Horizontal reach 18 meters

## Electric foggers

Guarany's Electric Disinfectant Fogger is used across the world for disinfecting and disease control. Its easy-to-use, portable design makes it suitable for use in a range of facilities such as offices, clinics, waiting rooms, schools, gyms etc.



### Features

- Variable flow rates
- Targets pathogens in air and on surfaces
- Light, easy to use
- Requires mains electricity
- Good for small-medium areas

## Air powered fogging stations

These machines provide great versatility for adapting to different application situations. They run entirely on compressed air and entrain the disinfectant via venturi suction. This results in a very finely atomised fog distributed efficiently by the air flow.

The system can either be permanently installed in a room or on a wheel mounted mobile unit which simply needs to be moved into the room being treated and connected to a suitable air supply.



### Features

- Just requires compressed air
- Flexible design
- 4 way fog projected 7.5 meters
- Delayed timer optional extra
- Variety of metering suction tips to ensure correct dosing

## Mobile air fogging system

This innovative solution allows for truly mobile spraying. The system runs from a compressed air tank and uses siphon fed air atomising nozzles to produce a very fine fog suitable for disinfection spraying.

As there are no pumps, motors or electrics the system is suitable for use in hazardous environments or areas where powered units cannot be used.



### Features

- Runs entirely from a compressed air tank
- Different nozzles and flow rates available
- Suitable for use in ATEX environments

## Complete fixed fogging systems

### Fastpass air powered vehicle fogging system

The FastPass system from world leading nozzle manufacturer BETE is an elegant solution for the rapid disinfection of vehicles. This system was originally developed for the sanitisation of school buses.

It is a modular system that can be permanently installed in any vehicle. To operate, it simply requires a pumped fluid and compressed air supply to be connected. Within minutes the entire vehicle will be effectively fogged.

#### Features

- Permanently installed in the vehicle
- Rapid disinfection
- Requires compressed air and pumped liquid supply
- Advanced air atomising nozzle system



### FlowMission Intelligent Sanitising System

The FlowMission system is an intelligent and modular sanitising solution that will only operate if bar-coded bottles of disinfectant are inserted. This ensures that only correct, verified and in-date product is used.

This system uses high pressure misting nozzles to generate a finely atomized spray. The nozzles can be arranged in clusters or individually to suit the space being treated.

#### Features

- Permanently installed in the vehicle
- Rapid disinfection
- Requires compressed air and pumped liquid supply
- Advanced air atomising nozzle system



## FOAMING SYSTEMS

The use of foams in cleaning systems serves two main purposes. Firstly the foamed cleaning agent will stick to surfaces for longer. This gives it more time to act on the residues that need to be broken down. Secondly the presence of foam can assist operators in the effectiveness of cleaning as it is a clear visual reminder of where the chemical has been applied.

The consistency of foams can vary greatly depending on the foaming agent being used and the amount mixed into the main water supply. Our systems help control this mix to give the desired consistency. The addition of compressed air into a foaming system gives an even greater degree of control over foam consistency allowing for very thick and long lasting foams to be generated.

### Airless foaming units

#### Venturi mix foaming station

These wall mounted foaming stations will automatically mix the desired foaming agent from a container. This occurs via the venturi principle so no dosing pump or pre-mixing is required. A mixed foamer/water solution will be delivered to any foaming gun attached to the system.



#### Features

- 1 or 2 way system for mixing two different foaming agents or concentrations
- Just needs mains water pressure to work
- Wide variety of metering tips allowing for precise mixing
- Wide range of hose and foam gun attachments

#### Foaming guns

A simple foam gun that just requires a water supply to operate. The foaming agent is contained within the pot under the gun and the level of mixing can be controlled via a number of different flow restrictors. This simple device gives surprising versatility around the factory.



#### Features

- 1 or 2 way system for mixing two different foaming agents or concentrations
- Just needs mains water pressure to work
- Wide variety of metering tips allowing for precise mixing
- Wide range of hose and foam gun attachments

#### Mobile foaming units

Mobile foaming units to deliver effective foams around the factory. These units only require a mains water supply to operate and will mix the foam concentrate at the trolley. They are available in a wide variety of configurations.



#### Features

- Only requires mains pressure water to operate
- Mixes the foaming agent at source via venturi action
- Wide variety of guns and hoses available
- Different sizes available

## Air pump foamers

### Wall mounted air pump foamer

Air pumps are an effective way of boosting fluid pressure without the need for electrically powered pumps. The air pump runs entirely on compressed air and allows for the delivery of medium to high volumes of pre-mixed foaming agent to distances of up to 5 metres.

These units are available with a number of options, hose lengths and foam gun styles.

### Mobile air pump foamer

A mobile air pump system that can deliver high-medium volume foam around the factory. This unit requires only air and water to operate.

They are available in a wide variety of sizes and options.



### Features

- Requires compressed air to operate
- Does not require mains water supply - it draws the pre-mix foaming agent from a static tank
- Ideal for areas without access to reliable water supply
- Different sizes available
- Robust stainless steel construction



## Air assisted foamers

### Wall mounted air assisted foaming

Introducing compressed air into a foaming system allows for the creation of thicker foams that cling to surfaces longer. By regulating the air-fluid mix a wide variety of different foam consistencies can be achieved from a single unit.

These wall mounted units regulate both the air mix and the venturi mixing of the foam concentrate with a mains water supply.



### Features

- Requires compressed air and mains water to operate
- Mixes foaming agent from concentrate
- Wide range of hoses and foaming guns available
- Robust stainless steel construction

### Conveyor mate foaming system

A very handy adaptation of the standard air assisted foam unit that allows for the foaming of conveyor systems. Available either as a single nozzle top down spray or a dual nozzle top and bottom foamer.



#### Features

- Requires compressed air and mains water to operate
- Mixes foaming agent from concentrate
- Robust stainless steel construction
- Fully adjustable foam nozzle height

### Entry way foaming system

As staff move from area to area there is always a potential for contamination to spread. These automatic systems lay down a regular layer of sanitising foam. This sticks to the shoes of anyone walking through it killing and removing pathogens more effectively than traditional dip tank systems.

As the foam is regularly renewed this eliminates the problem of "stale" and ineffective liquid entry protection systems.

#### Features

- Requires compressed air and mains water to operate
- Mixes foaming agent from concentrate
- Robust stainless steel construction

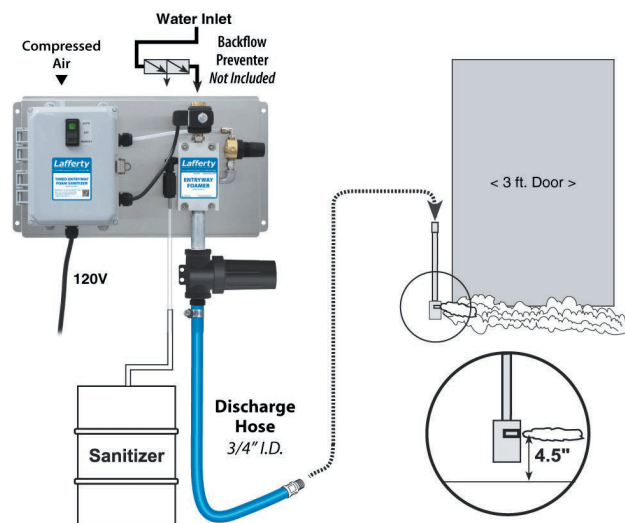



## TANK CLEANING

Cleaning tanks and vessels requires specialist cleaning heads. Ideally these cleaning heads will automatically clean the entire tank between uses without the need for any manual cleaning. A wide variety of cleaning heads are available from SNP to suit almost any residues or tank size.

### Rotary jet cleaners

The machines operate under fluid power alone. The arms move through a set cleaning cycle that ensures jets are brought to bear on each part of the tank ensuring a complete and very robust clean.

Rotary jet cleaners improve dramatically the mechanical action component of the cleaning mix. This means they are, generally, more water efficient than other tank cleaners.



#### Features

- Powerful cleaning jets
- Set cleaning cycle
- High mechanical action
- Suitable for tanks up to 25m in diameter
- Self cleaning hygienic design
- ATEX options available

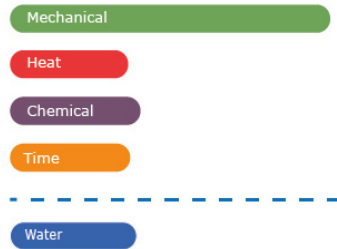
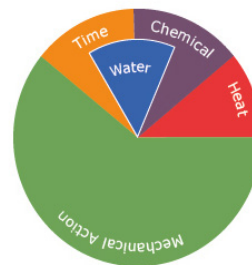

### Rotary cleaning heads

#### Standard Rotary Spray Balls

These cleaning heads operate by fluid power alone. They will run between 1 and 3 bar fluid pressure and offer a more robust mechanical action than static spray balls. They are suitable for small and medium sized vessels



#### Features

- Medium mechanical action
- Wide variety of sizes and flow rates
- Hygienic design
- ATEX options available
- All PTFE options available

#### PTFE cleaning heads

This variant of the standard stainless steel rotary head is entirely manufactured from PTFE. This is one of the most chemically inert materials known to man and so is suitable for use in extremely corrosive environments or with very aggressive caustics.

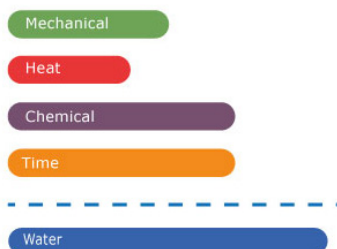
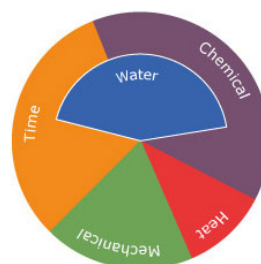

## Static spray balls

### Standard Spray Ball

These cost effective tank cleaning heads break apart a fluid flow into many micro-jets which fire in all directions. This ensures the cleaning fluid hits each part of the tank. Most of the cleaning is performed by the solvent properties of water and caustics so spray balls have a high water consumption.



### Features

- Low mechanical action
- No moving parts
- Hygienic design
- Wide range of flows and sizes
- Suitable for small to medium tanks
- Clog resistant options available

### HydroClaw clog resistant

The small holes on standard spray balls can become clogged if particles, pips or other contaminants are present in recirculated wash water. The HydroClaw's unique design solves this problem

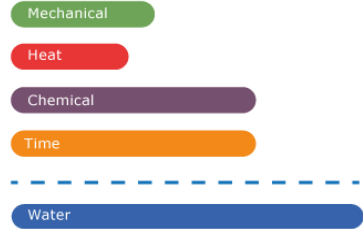
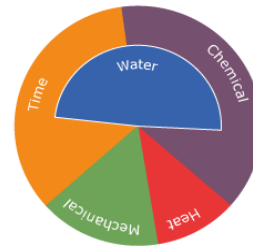

## Specialist tank cleaners

With our many decades of experience in designing tank cleaning systems we sometimes come across unique situations which need something outside the standard range of tank cleaners. Over the years we have developed many unique solutions for certain niches including resin cleaning, rapid IBC cleaning and the cleaning of large storm water tanks.

For complex tank cleaning systems we can deploy our years of accumulated specialist knowledge to design bespoke systems for almost any situation.

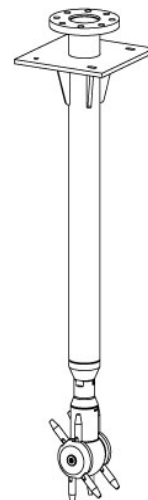
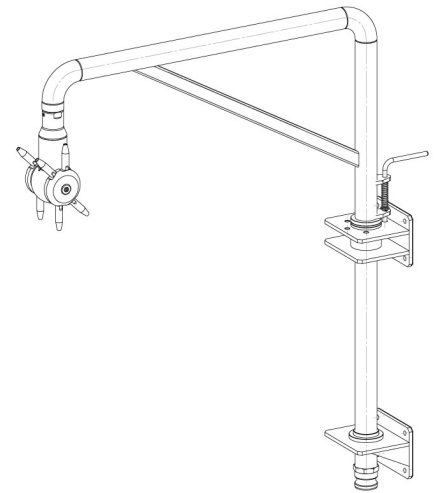



THE  
**SPRAY NOZZLE**  
PEOPLE

# About us

As the name would suggest, we are a specialist supplier of spray nozzles and systems including tank cleaning heads. Our products are used in many different industries and by companies of all sizes. We are comfortable dealing with large projects for blue chip food, beverage, chemical and petrochemical giants as well as start-ups or single person operations.

## Key Suppliers

**Lafferty**  
EQUIPMENT MANUFACTURING INC.

**BETE**<sup>®</sup>

**Dasic**  
group

**Guarany**



THE  
**SPRAY NOZZLE**  
PEOPLE



We have distribution agreements with multiple high quality manufacturers of nozzles, tank cleaning heads, sprayers, foamers, foggers and washdown equipment.

Primarily, we distribute the Lafferty range of mixing stations, washdown kit, foggers and foam units. Lafferty have a vast range of products only a selection of which is presented in this brochure.

For tank cleaning and nozzle systems we distribute the BETE and Dasic group ranges of equipment.

For manual and mobile spraying and fogging we distribute the world leading Guarany range of equipment

## The Group

The Spray Nozzle People are part of the Spray People Group. This group consists of four other business units focusing on specialist products (see right).



THE  
**SPRAY PEOPLE**  
GROUP



THE  
**SAFETY SHOWER**  
PEOPLE

Emergency Showers and eye baths



THE  
**AIR NOZZLE**  
PEOPLE

Air nozzles, air knives, vortex coolers and other air related products



THE  
**FULFILMENT**  
PEOPLE

Specialist high care warehousing and logistics



THE  
**PROFESSIONAL SPRAYERS**  
PEOPLE

Backpack and hand held spraying equipment

01273 400092  
info@spray-nozzle.co.uk  
www.spray-nozzle.co.uk



THE  
**SPRAY NOZZLE**  
PEOPLE

## **EFFECTIVE & EFFICIENT CLEANING AND SANTISING SYSTEMS FOR ALL INDUSTRY**

Food processing



Brewing and distilling



Waste Water Treatment



Chemical / Petrochemical



Pharmaceutical



### **The Spray Nozzle People**

PO Box 2748

Lewes

East Sussex

BN8 4HZ

Website: [www.spray-nozzle.co.uk](http://www.spray-nozzle.co.uk)

e-mail: [info@spray-nozzle.co.uk](mailto:info@spray-nozzle.co.uk)

Telephone: +44(0)1273 400092

01273 400092  
[info@spray-nozzle.co.uk](mailto:info@spray-nozzle.co.uk)  
[www.spray-nozzle.co.uk](http://www.spray-nozzle.co.uk)