

## SILENT X-STREAM™ AIR BLADE™ AIR KNIFE

Blowoff, clean, cool and dry with this quiet, sharp and strong focused curtain of air



### WHAT ARE THEY - REASONS TO USE

The Silent X-Stream™ Air Blade™ Air Knife is easy to mount and maintain, reducing both compressed air consumption and noise levels. It is the most efficient design yet achieved in Air Knife blow off technology in reducing noise levels and air consumption yet providing the optimum in blow off energy.

The Silent X-Stream™ Air Blade™ Air Knife produces a “laminar” flow of air along its length using the “Coanda” effect which “entrains” a large volume of air from the surrounding area along with a small amount of compressed air from the X-Stream™ Air Blade™ Air Knife to produce an output flow up to 40 times.

System payback on compressed air savings can be as soon as a few weeks in some applications.

The Silent X-Stream™ Air Blade™ Air Knife comes in three versions: Gold Anodized Aluminum for most applications, Hard Anodized aluminum for abrasive environments or where material may come in contact and tend to wear against the air knife, and stainless steel for high temperature and corrosive environments.

**NOTE:** Plastic shims can wear out quickly in Air Knives if the air is not clean. Nex Flow™ uses ONLY stainless steel shims.



Available in Hard Anodized aluminum for abrasive environments or where material may come in contact with the air knife.

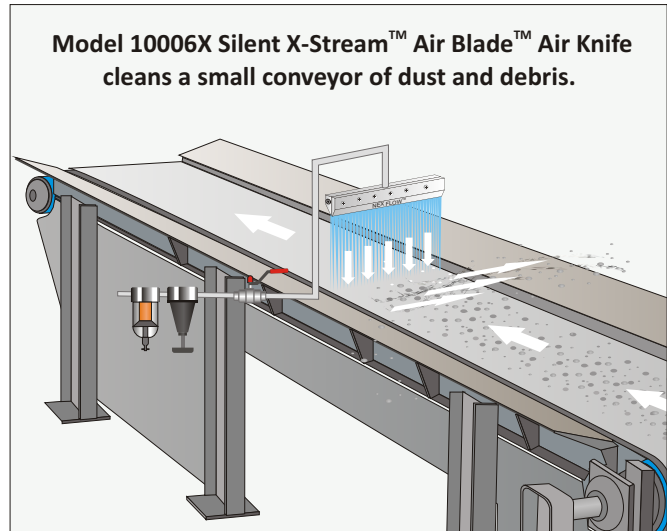

Model 10006X Silent X-Stream™ Air Blade™ Air Knife cleans a small conveyor of dust and debris.

### SILENT X-STREAM™ AIR BLADE™ AIR KNIFE FEATURES:

- ▶ **No moving parts - Gold Anodized aluminum, Hard Anodized aluminum or stainless steel.**
- ▶ Compact design, simple, lightweight and portable.
- ▶ Full flow - Air across entire length of Air Knife.
- ▶ Air inlets at ends and back.
- ▶ Driven by air not electricity.
- ▶ Replaces drilled pipe and open jets or nozzles used for blowoff, cleaning, drying and cooling.
- ▶ High airflow amplification.
- ▶ Instant on-off, no electricity or explosion hazard.

### SILENT X-STREAM™ AIR BLADE™ AIR KNIFE BENEFITS:

- ▶ Longer life in difficult environments than competitive models.
- ▶ Lower compressed air consumption than drilled pipe or rows of open jets and nozzles.
- ▶ Can be placed end to end for continuous airflow.
- ▶ Maintenance free with output easily controlled, safe to use.

### SILENT X-STREAM™ AIR BLADE™ AIR KNIFE ADVANTAGES OVER BLOWERS:

- ▶ Compact design, simple, lightweight and portable.
- ▶ Driven by air, not electricity for safety.
- ▶ No moving parts - Hence safer and maintenance free.
- ▶ Lower noise levels at 69 dBA and less with smaller space.



**SILENT X-STREAM™ AIR BLADE™ AIR KNIFE APPLICATIONS:**

- ▶ Cleaning of steel sheet in strip mills
- ▶ Parts drying
- ▶ Cleaning or drying web processes.
- ▶ Pre-paint drying and blowoff
- ▶ Scrap removal
- ▶ Parts cooling
- ▶ Circuit board cooling
- ▶ Use for environment separation with air curtain effect
- ▶ Opening bags for filling
- ▶ Sheet separation

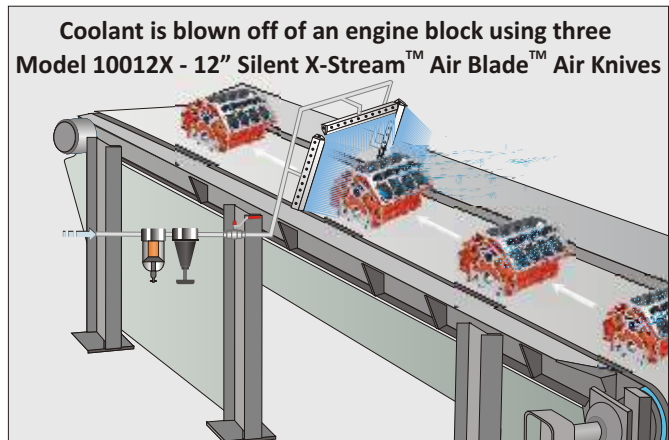

**SILENT X-STREAM™ AIR BLADE™ AIR KNIFE VERSES OTHER BLOWOFF PRODUCTS:**

1. **Drilled Pipe** - Typically drilled pipe uses more compressed air while producing inconsistent flow at high noise levels. The Silent X-Stream™ Air Blade™ Air Knife can usually cut air costs as much as 50%.
2. **Flat Air Nozzles** - These products can use even more compressed air than drilled holes with the same problems of inconsistent flow at high noise levels.
3. **Air Blowers** are capital intensive but can use less energy than compressed air operated air knives on a continual basis. However blowers cannot be cycled on and off quickly and can actually use the same or more energy in intermittent applications. Choosing a blower or Silent X-Stream™ Air Blade™ Air Knife depends on the following factors:
  - (A) **Availability of a particular energy source** - is electricity or air the most convenient.
  - (B) **Space and Weight** - These are important factors that affect the overall cost and maintenance of a system. The compressed air operated Air knife is light weight and compact.
  - (C) **Noise level** - The Silent X-Stream™ Air Blade™ Air Knife is intrinsically quiet while blower systems are noisy and require costly silencing.
  - (D) **Application particulars** - The specific application often determines what is best to use. Intermittent blowoff and/or tight spaces favor the use of the Silent X-Stream™ Air Blade™ Air Knife.
  - (E) **Reliability** - Blower systems require maintenance because they have moving parts. The Silent X-Stream™ Air Blade™ Air Knife requires no maintenance when properly filtered and is intrinsically the most reliable.
  - (F) **Energy Cost** - Energy cost can be less with a blower system especially on continuous blowoff applications. However, energy cost can often be offset against higher capital costs and maintenance costs when utilizing blower systems. The Silent X-stream™ Air Blade™ Air Knife is low cost with negligible maintenance.
  - (G) **System Cost** - Much higher for blower systems especially if silencing is required. It is low for Silent X-Stream™ Air Blade™ Air Knives.
  - (H) **Maintenance and Operating Cost** - The need for maintenance of blower systems can be a strong negative in some situations, especially if the blowers or electrical systems are in harsh environments. The Silent X-Stream™ Air Blade™ Air Knife however is resilient to harsh environments in comparison

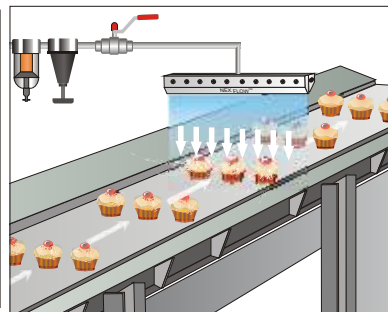
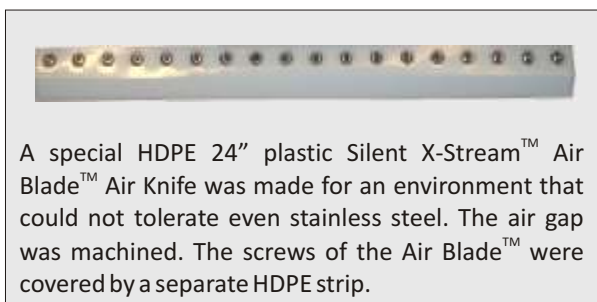

**AIR BLADE™ AIR KNIFE**



**SILENT X-STREAM™ AIR BLADE™ AIR KNIFE - HOW IT WORKS:**

**Silent X-Stream™ Air Blade™ Air Knife** - Compressed air enters the Air Knife at the rear (or end) ports at (A). Air is entrained at point (B) and (D) by the compressed air stream that leaves the Air Knife from a small gap at point (C). The entrained air follows the profile that directs the airflow in a perfect straight line to create a uniform sheet of air along the entire length of the Air Blade™ Air Knife. The amplified air stream maximizes velocity and force is maintained as a well defined sheet of laminar flow with minimal wind shear for reduced energy use in blowoff and cooling.

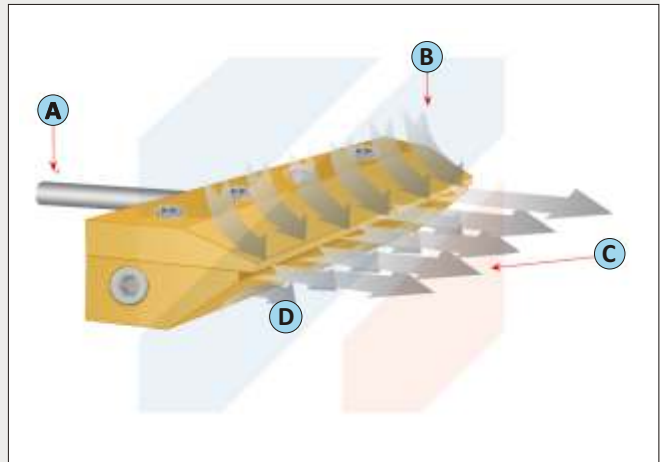

**X-Stream™ Air Blade™ Air Knife** is available in Eleven standard lengths in anodized aluminum and in Nine lengths in stainless steel: 2" (51 mm), 3" (76 mm), 6" (150 mm), 9" (229 mm), 12" (300 mm), 18" (457 mm), 24" (609.5 mm), 30" (761 mm), 36" (914 mm), and in aluminum only 42" (1066.8 mm) and 48" (1219.2 mm)

**GOLD ANODIZED AND HARD ANODIZED ALUMINUM SILENT X-STREAM™ AIR BLADE™ AIR KNIFE**

6" to 54" X-STREAM™ AIR BLADE™ AIR KNIVES ARE SUPPLIED WITH ADDITIONAL FLUSH PLUGS FOR THE UNUSED INLET PORTS

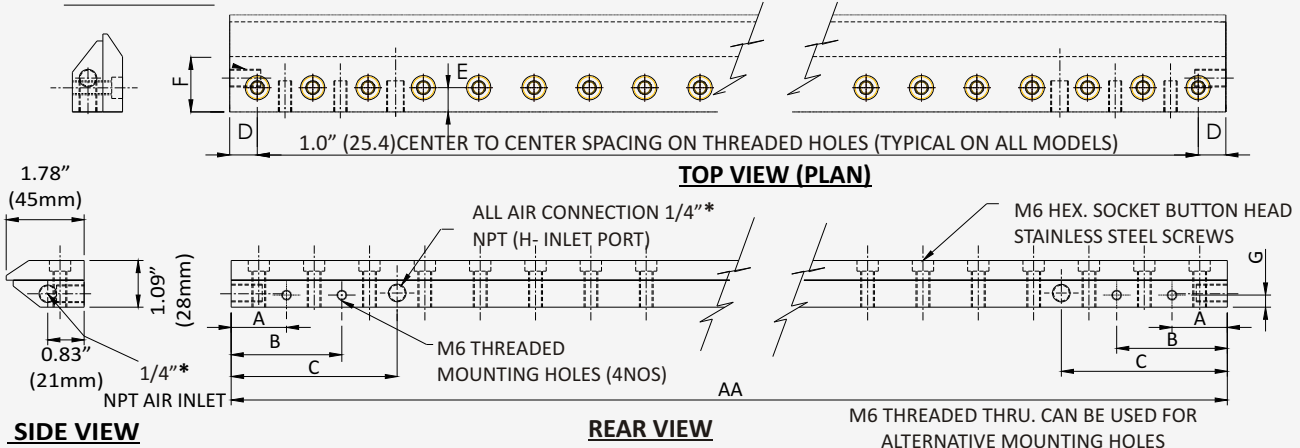

**STAINLESS STEEL SILENT X-STREAM™ AIR BLADE™ AIR KNIFE**

6" TO 36" X-STREAM™ AIR BLADE™ AIR KNIVES ARE SUPPLIED WITH ADDITIONAL FLUSH PLUGS FOR THE UNUSED INLET PORTS

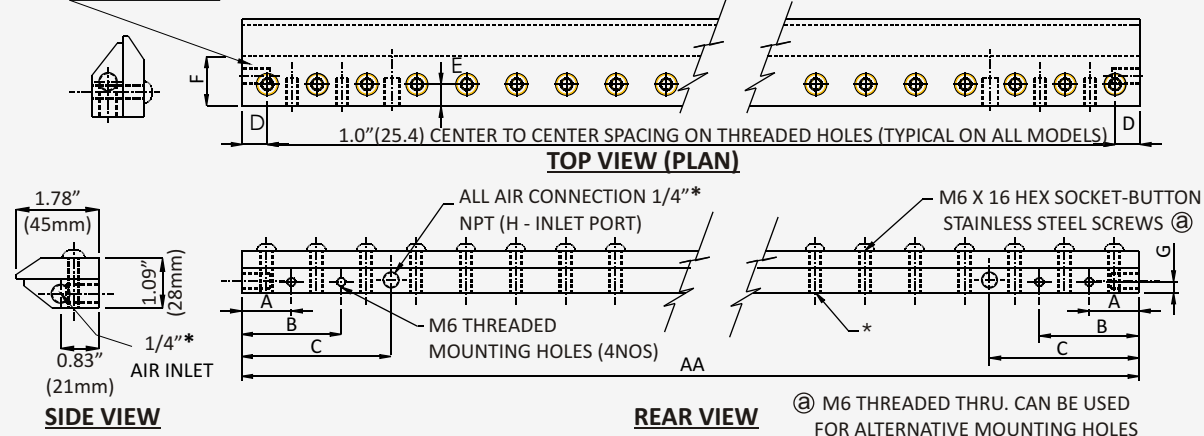

(\* BSP Threads or Adaptors can be supplied depending on country location)



**DIMENSION TABLE OF SILENT X-STREAM™ AIR BLADE™ AIR KNIFE – GOLD ANODIZED ALUMINUM**

PART NO. (Gold Anodized Alum.)	AA Inches (mm)	A Inches (mm)	B Inches (mm)	C Inches (mm)	D Inches (mm)	E Inches (mm)	F Inches (mm)	G Inches (mm)	No. of Rear Inlets (Side Inlets)
Model 10002X Gold Anodized Aluminum	2"(50.8)	N/A	N/A	1"(25.4)	0.5"(12.7)	0.438"(11)	N/A	N/A	1(0)
Model 10003X Gold Anodized Aluminum	3"(76.2)	.641"(16.3)	N/A	1.5"(38.1)	0.281"(7)	0.438"(11)	N/A	0.219"(5.56)	1(0)
Model 10006X Gold Anodized Aluminum	6"(152)	1"(25.4)	2"(50.8)	3"(76.2)	0.5"(12.7)	0.438"(11)	0.813"(21)	0.219"(5.56)	1(2)
Model 10009X Gold Anodized Aluminum	9"(229)	1"(25.4)	2"(50.8)	3"(76.2)	0.5"(12.7)	0.438"(11)	0.813"(21)	0.219"(5.56)	2(2)
Model 10012X Gold Anodized Aluminum	12"(305)	1"(25.4)	2"(50.8)	3"(76.2)	0.5"(12.7)	0.438"(11)	0.813"(21)	0.219"(5.56)	2(2)
Model 10018X Gold Anodized Aluminum	18"(457)	1"(25.4)	2"(50.8)	5"(127)	0.5"(12.7)	0.438"(11)	0.813"(21)	0.219"(5.56)	2(2)
Model 10024X Gold Anodized Aluminum	24"(610)	1"(25.4)	2"(50.8)	6"(152.4)	0.5"(12.7)	0.438"(11)	0.813"(21)	0.219"(5.56)	2(2)
Model 10030X Gold Anodized Aluminum	30"(761)	1"(25.4)	2"(50.8)	6"(152.4)	0.5"(12.7)	0.438"(11)	0.813"(21)	0.219"(5.56)	2(2)
Model 10036X Gold Anodized Aluminum	36"(914)	1"(25.4)	2"(50.8)	6"(152.4)	0.5"(12.7)	0.438"(11)	0.813"(21)	0.219"(5.56)	2(2)
Model 10042X Gold Anodized Aluminum	42"(1067)	1"(25.4)	2"(50.8)	6"(152.4)	0.5"(12.7)	0.438"(11)	0.813"(21)	0.219"(5.56)	2(2)
Model 10048X Gold Anodized Aluminum	48"(1219)	1"(25.4)	2"(50.8)	9"(228.6)	0.5"(12.7)	0.438"(11)	0.813"(21)	0.219"(5.56)	3(2)
Model 10054X Gold Anodized Aluminum	54"(1372)	1"(25.4)	2"(50.8)	9"(228.6)	0.5"(12.7)	0.438"(11)	0.813"(21)	0.219"(5.56)	3(2)

**NOTE:** For sizes 48" and longer there is a third rear inlet port in the middle, 3/8" NPT on same level as the other two rear inlet ports.

**USE OF SHIMS:**

Nex Flow™ uses **ONLY** stainless steel shims in their Air Knife products as plastic shims wear out over time and require replacement, even with relatively clean air systems. Stainless steel shims are .002" (.050 mm). In most applications this is adequate. However, velocity and force can be increased approximately 30% by adding a second .002" (.050 mm) shim. Shims may be stacked up to 5 sets. If using three or more sets however, the air inlets at the "ends" should be used to maintain even flow along the Air Knife system. Otherwise a slight drop in pressure and flow will occur across from the rear inlet ports if they are used with three or more shims. Note that noise levels and air use will go up with an increased number of shims.

**MOUNTING:**

Mounting holes are provided for easy mounting of the Silent X-Stream™ Air Blade™. In addition, the holes at the bottom of the unit may also be used for mounting.

**SPECIAL AIR KNIVES:**

Do you need a special length? Do you need a different shape or profile or material? Nex Flow™ can supply special units and address any unique situation. We have produced special lengths and made Air Knives in HDPE and other materials as requested.

**ACCESSORIES:**

It is important to keep the air supply clean and dry. We recommend a water removal filter with a float type automatic drain with a minimum filtration of 5 micron. If there is a chance of oil in the lines, we suggest an oil removal filter as well with a minimum filtration of 0.3 micron, also with an automatic drain. To minimize air use, we recommend a regulator with gauge to set the minimum pressure necessary to operate the system. If the system can be turned on and off as necessary, we recommend a system such as our PLCFC System as described in Section A.



**DIMENSION TABLE OF SILENT X-STREAM™ AIR BLADE™ AIR KNIFE – HARD ANODIZED ALUMINUM**

PART NO. (Hard Anodized Alum.)	AA Inches (mm)	A Inches (mm)	B Inches (mm)	C Inches (mm)	D Inches (mm)	E Inches (mm)	F Inches (mm)	G Inches (mm)	No. of Rear Inlets (Side Inlets)
Model 10002XHA Hard Anodized Aluminum	2"(50.8)	N/A	N/A	1"(25.4)	0.5"(12.7)	0.438"(11)	N/A	N/A	1(0)
Model 10003XHA Hard Anodized Aluminum	3"(76.2)	.641"(16.3)	N/A	1.5"(38.1)	0.281"(7)	0.438"(11)	N/A	0.219"(5.56)	1(0)
Model 10006XHA Hard Anodized Aluminum	6"(152)	1"(25.4)	2"(50.8)	3"(76.2)	0.5"(12.7)	0.438"(11)	0.813"(21)	0.219"(5.56)	1(2)
Model 10009XHA Hard Anodized Aluminum	9"(229)	1"(25.4)	2"(50.8)	3"(76.2)	0.5"(12.7)	0.438"(11)	0.813"(21)	0.219"(5.56)	2(2)
Model 10012XHA Hard Anodized Aluminum	12"(305)	1"(25.4)	2"(50.8)	3"(76.2)	0.5"(12.7)	0.438"(11)	0.813"(21)	0.219"(5.56)	2(2)
Model 10018XHA Hard Anodized Aluminum	18"(457)	1"(25.4)	2"(50.8)	5"(127)	0.5"(12.7)	0.438"(11)	0.813"(21)	0.219"(5.56)	2(2)
Model 10024XHA Hard Anodized Aluminum	24"(610)	1"(25.4)	2"(50.8)	6"(152.4)	0.5"(12.7)	0.438"(11)	0.813"(21)	0.219"(5.56)	2(2)
Model 10030XHA Hard Anodized Aluminum	30"(761)	1"(25.4)	2"(50.8)	6"(152.4)	0.5"(12.7)	0.438"(11)	0.813"(21)	0.219"(5.56)	2(2)
Model 10036XHA Hard Anodized Aluminum	36"(914)	1"(25.4)	2"(50.8)	6"(152.4)	0.5"(12.7)	0.438"(11)	0.813"(21)	0.219"(5.56)	2(2)
Model 10042XHA Hard Anodized Aluminum	42"(1067)	1"(25.4)	2"(50.8)	6"(152.4)	0.5"(12.7)	0.438"(11)	0.813"(21)	0.219"(5.56)	2(2)
Model 10048XHA Hard Anodized Aluminum	48"(1219)	1"(25.4)	2"(50.8)	9"(228.6)	0.5"(12.7)	0.438"(11)	0.813"(21)	0.219"(5.56)	3(2)
Model 10054XHA Hard Anodized Aluminum	54"(1372)	1"(25.4)	2"(50.8)	9"(228.6)	0.5"(12.7)	0.438"(11)	0.813"(21)	0.219"(5.56)	3(2)

**NOTE:** For sizes 48" and longer there is a third rear inlet port in the middle, 7" NPT on same level as the other two rear inlet ports.

#### USE OF SHIMS:

Nex Flow™ uses **ONLY** stainless steel shims in their Air Knife products as plastic shims wear out over time and require replacement, even with relatively clean air systems. Stainless steel shims are .002" (.050 mm). In most applications this is adequate. However, velocity and force can be increased approximately 30% by adding a second .002" (.050 mm) shim. Shims may be stacked up to 5 sets. If using three or more sets however, the air inlets at the "ends" should be used to maintain even flow along the Air Knife system. Otherwise a slight drop in pressure and flow will occur across from the rear inlet ports if they are used with three or more shims. Note that noise levels and air use will go up with an increased number of shims.

#### MOUNTING:

Mounting holes are provided for easy mounting of the Silent X-Stream™ Air Blade™. In addition, the holes at the bottom of the unit may also be used for mounting.

#### SPECIAL AIR KNIVES:

Do you need a special length? Do you need a different shape or profile or material? Nex Flow™ can supply special units and address any unique situation. We have produced special lengths and made Air Knives in HDPE and other materials as requested.

#### ACCESSORIES:

It is important to keep the air supply clean and dry. We recommend a water removal filter with a float type automatic drain with a minimum filtration of 5 micron. If there is a chance of oil in the lines, we suggest an oil removal filter as well with a minimum filtration of 0.3 micron, also with an automatic drain. To minimize air use, we recommend a regulator with gauge to set the minimum pressure necessary to operate the system. If the system can be turned on and off as necessary, we recommend a system such as our PLCFC System as described in Section A.



**DIMENSION TABLE OF SILENT X-STREAM™ AIR BLADE™ AIR KNIFE – STAINLESS STEEL**

PART NO. (Stainless Steel)	AA Inches (mm)	A Inches (mm)	B Inches (mm)	C Inches (mm)	D Inches (mm)	E Inches (mm)	F Inches (mm)	G Inches (mm)	No. of Rear Inlets (Side Inlets)
Model 10002XS stainless	2"(50.8)	N/A	N/A	1"(25.4)	0.5"(12.7)	0.438"(11)	N/A	N/A	1(0)
Model 10003XS stainless	3"(76.2)	.641"(16.3)	N/A	1.5"(38.1)	0.281"(7)	0.438"(11)	N/A	0.219"(5.56)	1(0)
Model 10006XS stainless	6"(152)	1"(25.4)	2"(50.8)	3"(76.2)	0.5"(12.7)	0.438"(11)	0.813"(21)	0.219"(5.56)	1(2)
Model 10009XS stainless	9"(229)	1"(25.4)	2"(50.8)	3"(76.2)	0.5"(12.7)	0.438"(11)	0.813"(21)	0.219"(5.56)	2(2)
Model 10012XS stainless	12"(305)	1"(25.4)	2"(50.8)	3"(76.2)	0.5"(12.7)	0.438"(11)	0.813"(21)	0.219"(5.56)	2(2)
Model 10018XS stainless	18"(457)	1"(25.4)	2"(50.8)	5"(127)	0.5"(12.7)	0.438"(11)	0.813"(21)	0.219"(5.56)	2(2)
Model 10024XS stainless	24"(610)	1"(25.4)	2"(50.8)	6"(152.4)	0.5"(12.7)	0.438"(11)	0.813"(21)	0.219"(5.56)	2(2)
Model 10030XS stainless	30"(761)	1"(25.4)	2"(50.8)	6"(152.4)	0.5"(12.7)	0.438"(11)	0.813"(21)	0.219"(5.56)	2(2)
Model 10036XS stainless	36"(914)	1"(25.4)	2"(50.8)	6"(152.4)	0.5"(12.7)	0.438"(11)	0.813"(21)	0.219"(5.56)	2(2)

**USE OF SHIMS:**

Nex Flow™ uses **ONLY** stainless steel shims in their Air Knife products as plastic shims wear out over time and require replacement, even with relatively clean air systems. Stainless steel shims are .002" (.050 mm). In most applications this is adequate. However, velocity and force can be increased approximately 30% by adding a second .002" (.050 mm) shim. Shims may be stacked up to 5 sets. If using three or more sets however, the air inlets at the "ends" should be used to maintain even flow along the Air Knife system. Otherwise a slight drop in pressure and flow will occur across from the rear inlet ports if they are used with three or more shims. Note that noise levels and air use will go up with an increased number of shims.

**MOUNTING:**

Mounting holes are provided for easy mounting of the Silent X-Stream™ Air Blade™. In addition, the holes at the bottom of the unit may also be used for mounting.

**SPECIAL AIR KNIVES:**

Do you need a special length? Do you need a different shape or profile or material? Nex Flow™ can supply special units and address any unique situation. We have produced special lengths and made Air Knives in HDPE and other materials as requested.

**ACCESSORIES:**

It is important to keep the air supply clean and dry. We recommend a water removal filter with a float type automatic drain with a minimum filtration of 5 micron. If there is a chance of oil in the lines, we suggest an oil removal filter as well with a minimum filtration of 0.3 micron, also with an automatic drain. To minimize air use, we recommend a regulator with gauge to set the minimum pressure necessary to operate the system. If the system can be turned on and off as necessary, we recommend a system such as our PLCFC System as described in Section A.

**AIR BLADE™ AIR KNIFE**

**Inlet Pressure Upstream vs. Air Consumption Per Inch for Silent X-Stream™ Air Blade™ Air Knife**

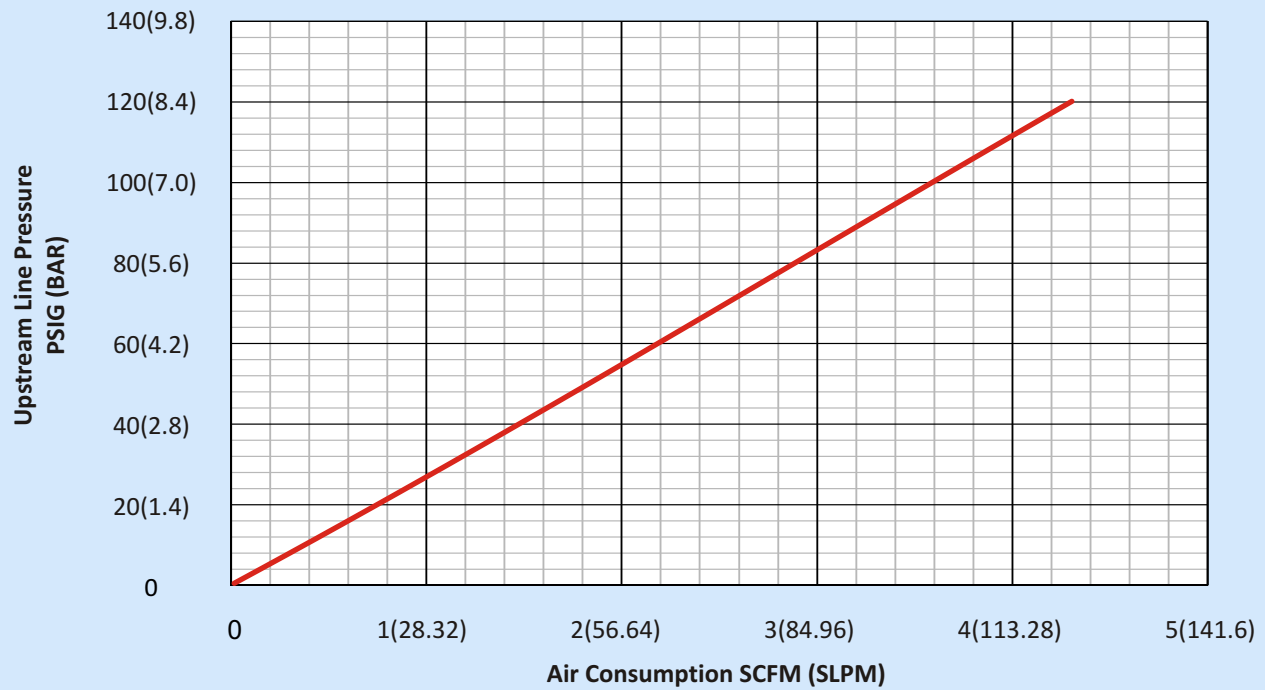

NOTE: Tests were performed using a 12" Model 10012X Silent X-Stream™ Air Blade™ Air Knife

**Inlet Pressure Upstream vs. Sound level at 3 feet (0.91m) for Silent X-Stream™ Air Blade™ Air Knife**

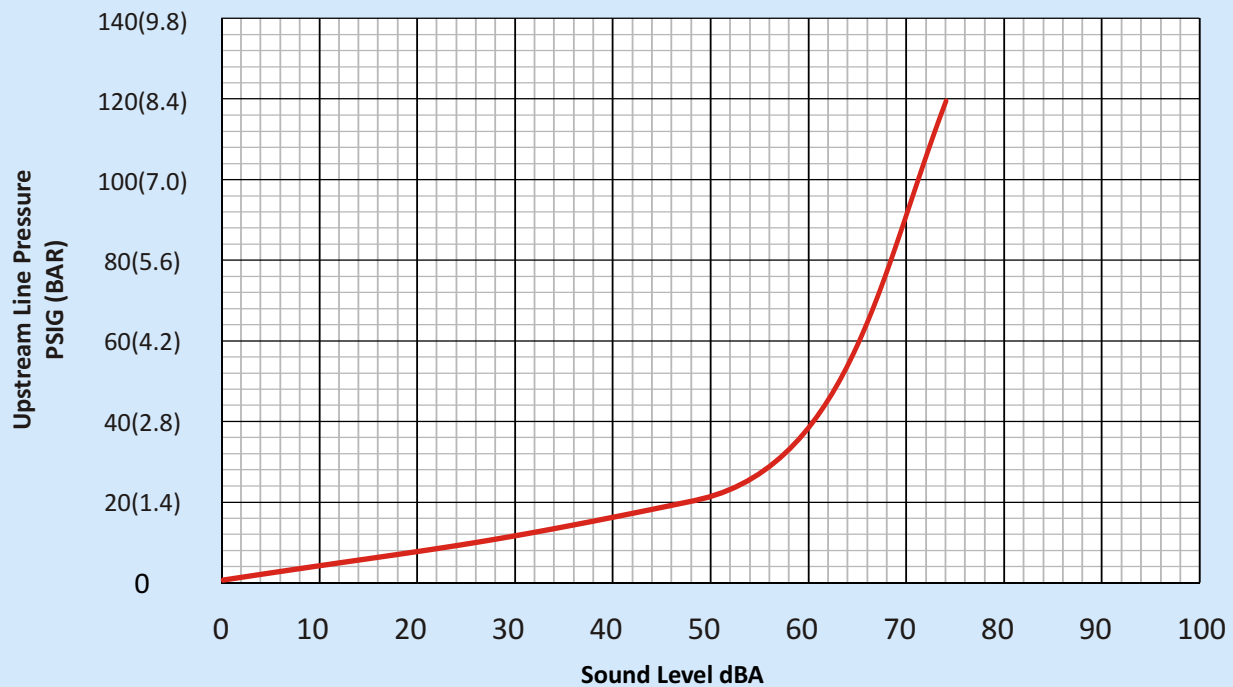

NOTE: Tests were performed using a 12" Model 10012X Silent X-Stream™ Air Blade™ Air Knife



**Actual Force Per Inch for Silent X-Stream™ Air Blade™ Air Knife**

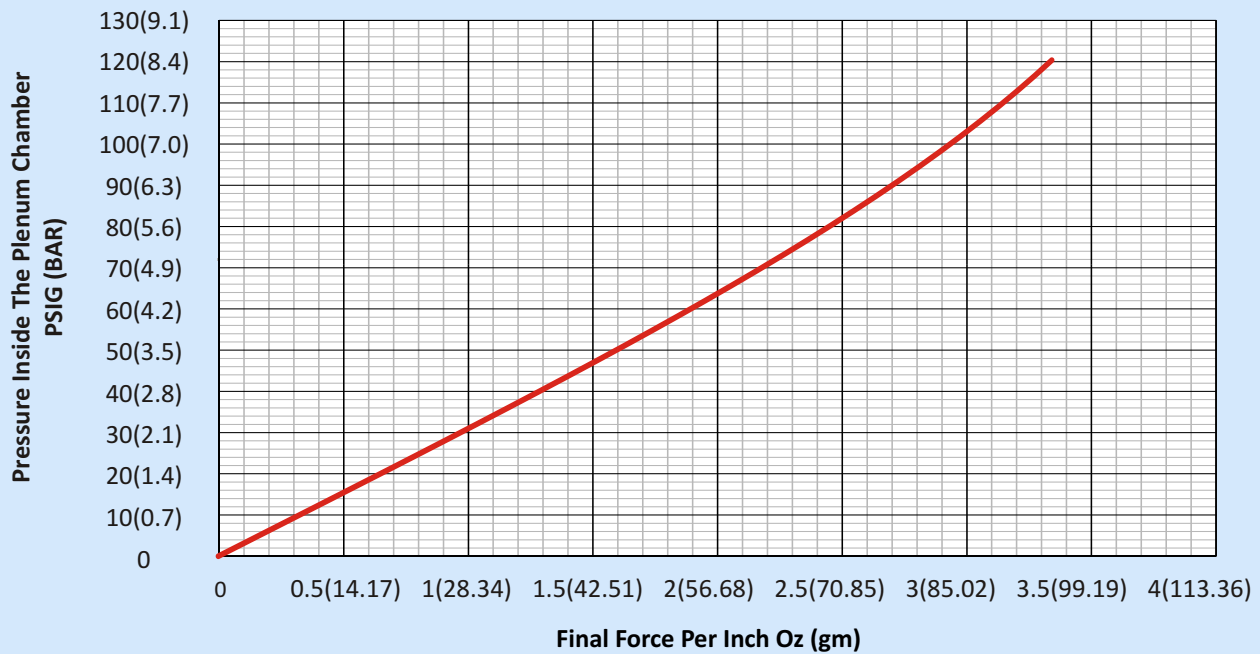

**NOTE:**

Force per inch of Air Knife was based on tests done with a 12" Silent X-Stream™ Air Blade™ Air Knife with a .002" (.050 mm) gap. Force was measured at a target 6" from the Air Knife.

*Actual results may vary due to tolerance variations.*

*Estimate 30% more force with a .004" (.100 mm) gap.*

**FORCE PER INCH EXPLANATION**

The pressure is measured at the chamber inside the X-Stream™ Air Blade™ Air Knife and not upstream. The force per inch is from tests using a 12" X-Stream™ Air Blade™ Air Knife with the graph extrapolated for higher end pressures. Figures will vary with the length of the Air Knife. The longer the Air Knife, the less the chamber pressure will be and the force per inch will also decrease. This is because of the limited size and volume of the chamber and also because of the limited air inlet holes.

Estimated chamber pressure inside the X-Stream™ Air Blade™ Air Knife as a percentage of upstream line pressure can be reasonably estimated as follows. Size of air lines, upstream pressure, and piping configurations can cause a great variation in actual force produced and actual pressure formed in the chamber of the Air Knife. However, for general engineering applications the multiplication factors as shown in the graph "Multiplication Factors to Obtain Plenum Pressure for Silent X-Stream™ Air Blade™ Air Knife" can be used to estimate the plenum pressure. Then you can obtain the force per inch from the Actual Force per inch graph.

- ▶ In general, the force per inch will be greater for shorter length X-Stream™ Air Blade™ Air Knives.
- ▶ If a particular application requires a greater force, it may be more useful to have several smaller length air knives than one larger one.

**EXAMPLE:**

Two (2) 12" X-Stream™ Air Blade™ Air Knives with a line pressure of 80 psig can be estimated to have a chamber pressure of 0.90 times the line pressure or  $0.9 \times 80 = 72$  psig. The force per inch from the Force graph at 72 psig is about 2.2 oz per inch for a total of  $2.2 \times 24 = 48$  oz force.

One (1) 24" X-Stream™ Air Blade™ Air Knife with a line pressure of 80 psig can be estimated to have a chamber pressure of 0.70 times the line pressure of  $0.7 \times 80 = 56$  psig.

The force per inch from the Force graph at 56 psig is  $1.8 \times 24 = 43$  oz force.

**In most applications a single 24" Air Knife will work but in applications where force is critical, it can make sense to use several smaller Air Knives instead.**





**Multiplication Factors to Obtain Plenum Pressure for Silent X-Stream™ Air Blade™ Air Knife**

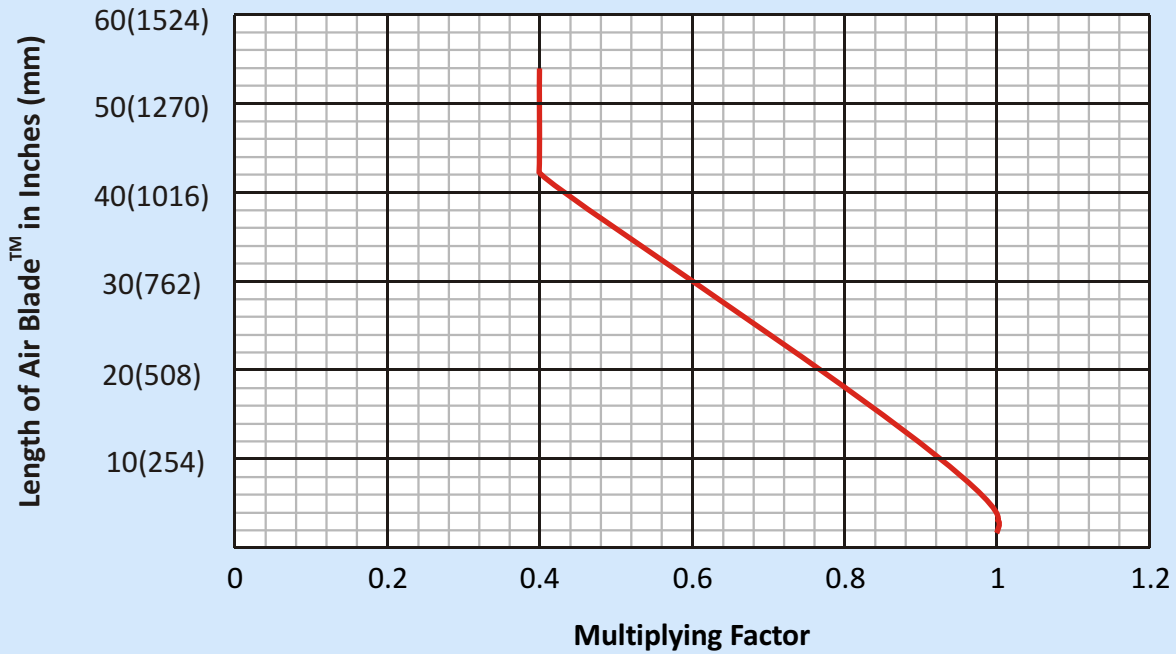

**NOTE:** These multipliers are based on having a large compressed air supply with air lines in the 1" range and with the location of use mid-plant. If the location is near the end of a long air line run, if there is a heavy use load and if air lines are small the multiplier can be reduced as much as 50%.

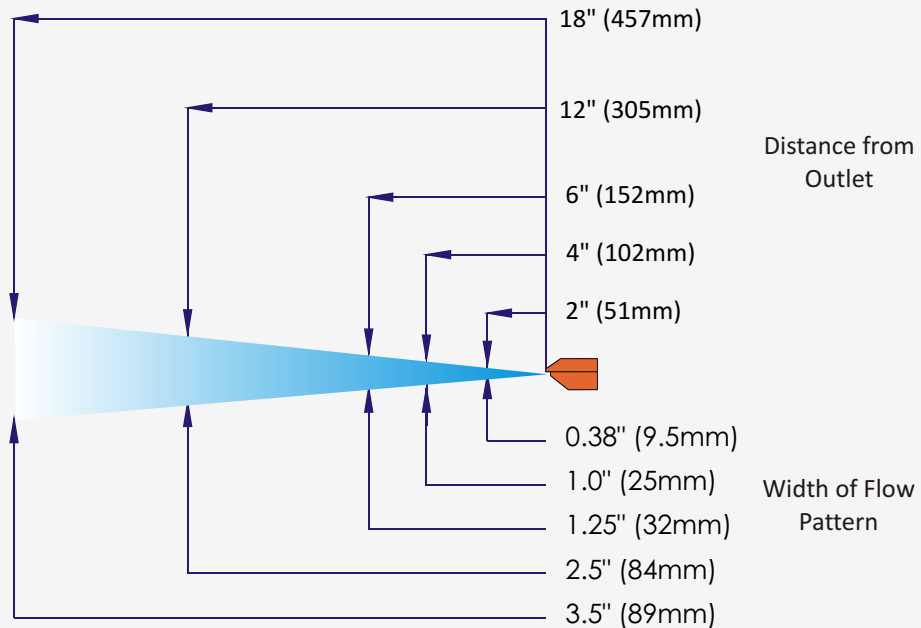

**SUPER QUIET, SUPER CONCENTRATED KNIFE EDGE AIR STREAM**  
**PROFILE OF SILENT X-STREAM™ AIR BLADE™ AIR KNIFE**



**Force per Inch at Various Distance from Target at 80 PSIG Plenum Pressure for Silent X-Stream™ Air Blade™ Air Knife**

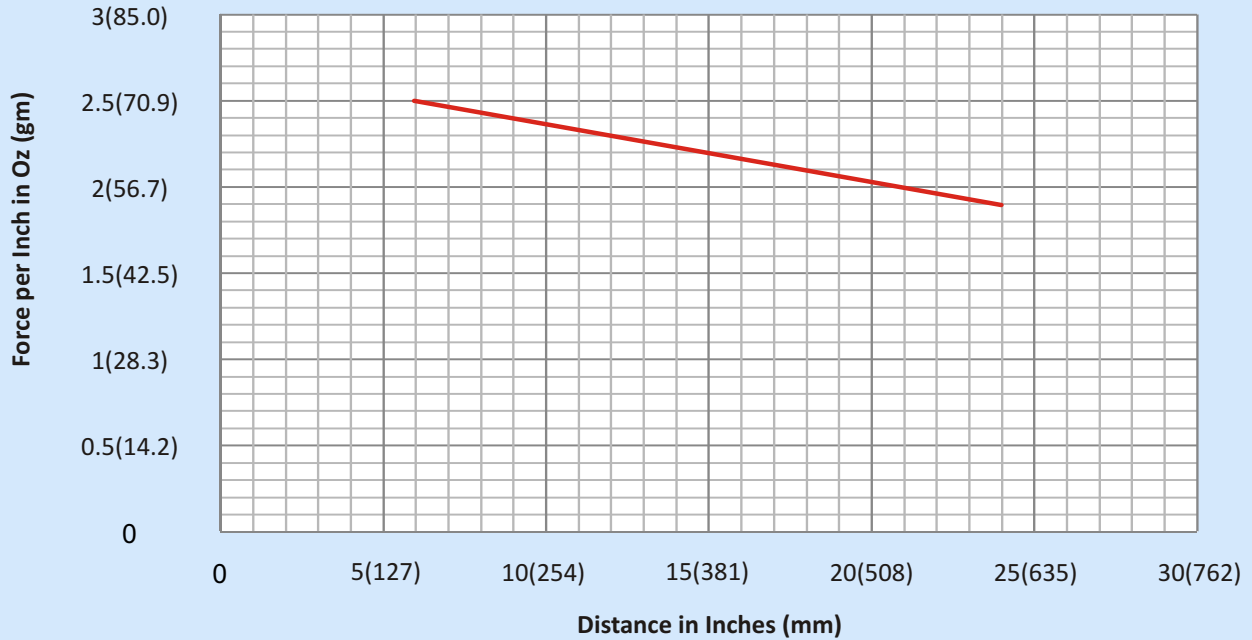

**NOTE:** Tests were performed using a 12" Model 10012X Silent X-Stream™ Air Blade™ Air Knife

**ACCESSORIES**

It is important to keep the air supply clean and dry. We recommend a water removal filter with a float type automatic drain with a minimum filtration of 5 micron. If there is a chance of oil in the lines, we suggest an oil removal filter as well with a minimum filtration of 0.3 micron, also with an automatic drain.

To minimize air use, we recommend a regulator with gauge to set the minimum pressure necessary to operate the system. If the system can be turned on and off as necessary, we recommend a system such as our PLCFC System as described in Section A.

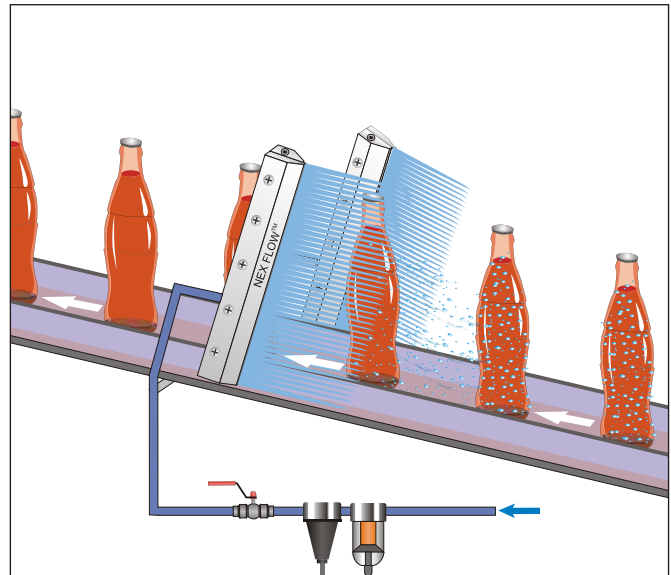

**OPTIONAL SILENT X-STREAM™ AIR BLADE™ AIR KNIFE COUPLING KIT.**



This one piece kit c/w 10 stainless steel screws connects any two Silent X-Stream™ Air Blade™ Air Knife of 6" or larger together to make a longer blowoff system to cover greater distances. The units come in three models. Model 10900X gold anodized aluminum for the gold anodized aluminum Silent X-Stream™ Air Blade™ Air Knives, Model 10900XHA for the Hard Anodized units, and Model 10900XS stainless for stainless steel models.

**AIR BLADE™ AIR KNIFE**

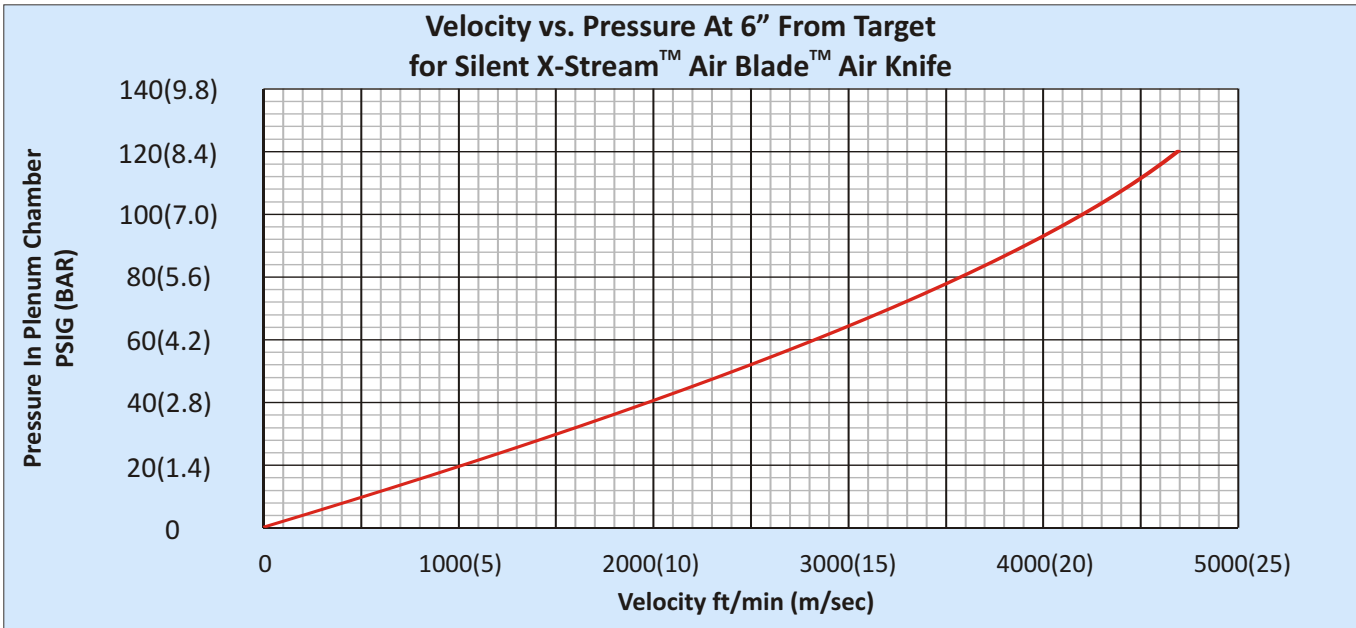

**NOTE:** Tests were performed using a 12" Model 10012X Silent X-Stream™ Air Blade™ Air Knife

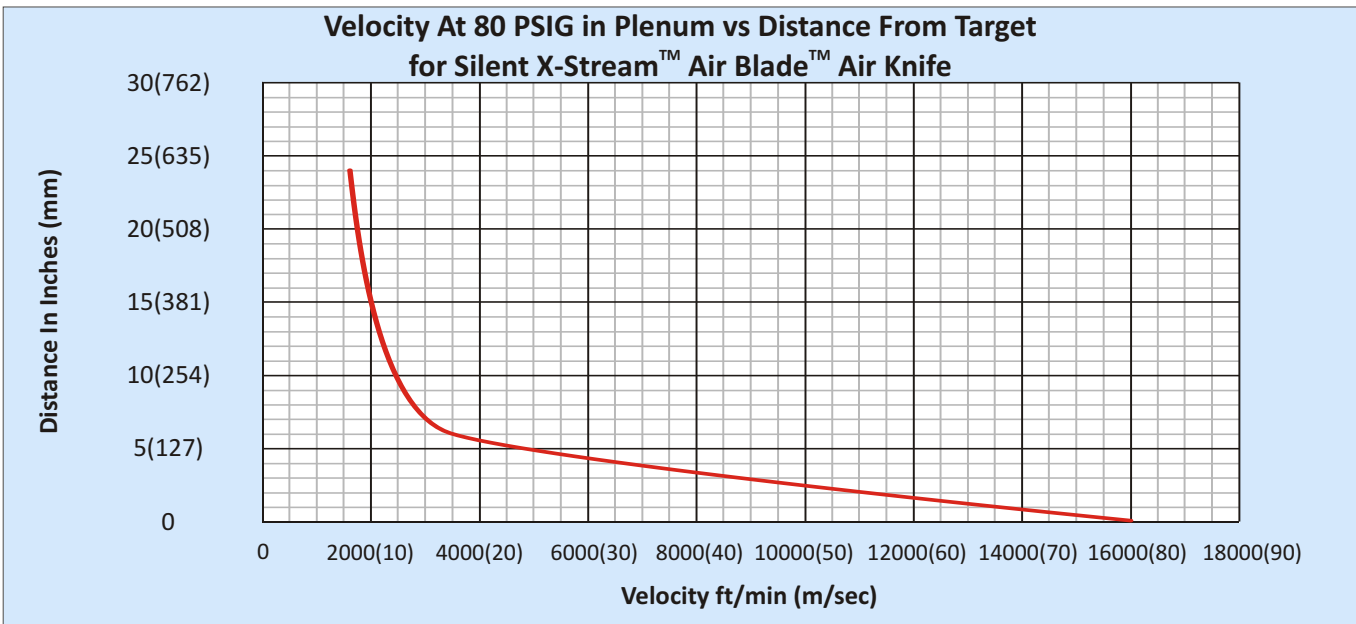

**NOTE:** Tests were performed using a 12" Model 10012X Silent X-Stream™ Air Blade™ Air Knife

Velocity is important in that it can determine the cooling effect and is also related to the blowoff force. Velocity will vary significantly depending on the temperature of the ambient air - The hotter the air, the greater the velocity (and the greater the amplification of the air flow). So velocity figures at best are an approximation. As air is entrained, the flow increases and as the flow increases the velocity must come down. The velocity at the exit of the Silent X-Stream™ Air Blade™ Air Knife is the highest but the figure is of no value as once the surrounding air is entrained, the velocity drops dramatically. (Be wary of extremely high velocity claims downstream of any Air Knife or Air Amplifier). The figures provided by Nex Flow™ can be verified with a velocity meter. There will be some variations in measurement due to different air pressure and atmospheric conditions. The velocity is, among other things, dependent on the chamber pressure. That pressure in turn depends upon pipe size, pressure drops in the system, distance from the compressor station to the point of use, and many other factors. (See previous pages regarding plenum chamber pressure and force estimates).



**CALCULATING AIR SAVINGS**

The chart below shows the air consumption at different upstream air inlet pressures for various hole sizes and the air consumption per inch of a Silent X-Stream™ Air Blade™ Air Knife.

To obtain the air consumption of drilled holes in pipe determine the size of the holes and multiply the air loss by the number of holes over the length.

The air usage of the Silent X-stream™ Air Blade™ Air Knife is per inch. Multiply the figure from the chart by the length of the air knife.

**EXAMPLE:**

Assume an existing blowoff of a 24" long pipe with 3/32" holes spaced 3/4" inches apart for a total of 32 holes. At 80 PSIG from the graph each hole consumes about 9.4 SCFM for a total of 32 X 9.4 = 300.8 SCFM

At 80 PSIG a 24" X-Stream™ Air Blade™ Air Knife consumes 24 X 2.9 SCFM/inch = 69.6 SCFM

Compressed air saved is 300.8 - 69.6 = 231.2 SCFM

Using actual air costs if known (or assuming a reasonable cost of \$.30 US per 1000 cubic feet) the dollars saved is 231.2 X 60 X 0.30/1000 = \$4.16 /hr or assuming an 2000 hour working year = \$8320.00 SAVED PER YEAR

Please refer to the Addendum on the explanation of Air Flow Amplification for a detailed explanation on what it is and how air amplification works.

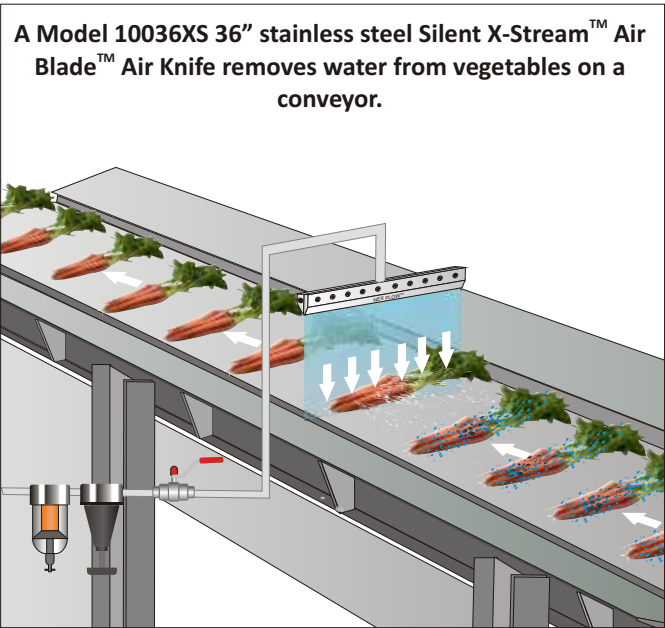

**AIR BLADE™ AIR KNIFE**



**B  
12**

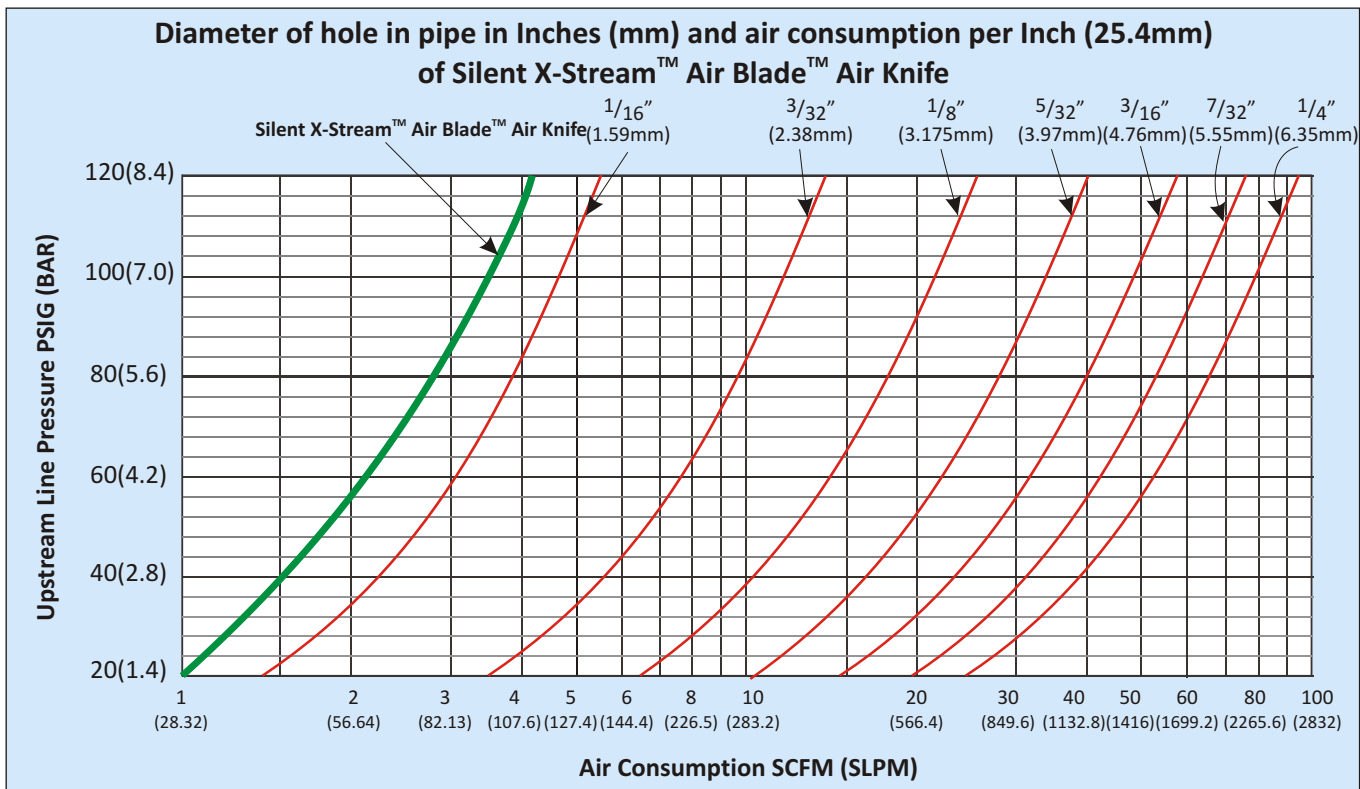

### Gold Anodized Aluminum X-Stream™ Full-Flow Air Blade™ Air Knives

PART NO.	DESCRIPTION
10002X	2" Gold Anodized Alum. X-Stream™ Air Blade™ Air Knife Only
10003X	3" Gold Anodized Alum. X-Stream™ Air Blade™ Air Knife Only
10006X	6" Gold Anodized Alum. X-Stream™ Air Blade™ Air Knife Only
10009X	9" Gold Anodized Alum. X-Stream™ Air Blade™ Air Knife Only
10012X	12" Gold Anodized Alum. X-Stream™ Air Blade™ Air Knife Only
10018X	18" Gold Anodized Alum. X-Stream™ Air Blade™ Air Knife Only
10024X	24" Gold Anodized Alum. X-Stream™ Air Blade™ Air Knife Only
10030X	30" Gold Anodized Alum. X-Stream™ Air Blade™ Air Knife Only
10036X	36" Gold Anodized Alum. X-Stream™ Air Blade™ Air Knife Only
10042X	42" Gold Anodized Alum. X-Stream™ Air Blade™ Air Knife Only
10048X	48" Gold Anodized Alum. X-Stream™ Air Blade™ Air Knife Only
10054X	54" Gold Anodized Alum. X-Stream™ Air Blade™ Air Knife Only
11002X	2" Gold Anodized Alum. X-Stream™ Air Blade™ Air Knife plus Filter with Auto Drain
11003X	3" Gold Anodized Alum. X-Stream™ Air Blade™ Air Knife plus Filter with Auto Drain
11006X	6" Gold Anodized Alum. X-Stream™ Air Blade™ Air Knife plus Filter with Auto Drain
11009X	9" Gold Anodized Alum. X-Stream™ Air Blade™ Air Knife plus Filter with Auto Drain
11012X	12" Gold Anodized Alum. X-Stream™ Air Blade™ Air Knife plus Filter with Auto Drain
11018X	18" Gold Anodized Alum. X-Stream™ Air Blade™ Air Knife plus Filter with Auto Drain
11024X	24" Gold Anodized Alum. X-Stream™ Air Blade™ Air Knife plus Filter with Auto Drain
11030X	30" Gold Anodized Alum. X-Stream™ Air Blade™ Air Knife plus Filter with Auto Drain
11036X	36" Gold Anodized Alum. X-Stream™ Air Blade™ Air Knife plus Filter with Auto Drain
11042X	42" Gold Anodized Alum. X-Stream™ Air Blade™ Air Knife plus Filter with Auto Drain
11048X	48" Gold Anodized Alum. X-Stream™ Air Blade™ Air Knife plus Filter with Auto Drain
11054X	54" Gold Anodized Alum. X-Stream™ Air Blade™ Air Knife plus Filter with Auto Drain
12002X	2" Gold Anodized Alum. X-Stream™ Air Blade™ Air Knife + Filter with Auto Drain + Regulator with Gauge
12003X	3" Gold Anodized Alum. X-Stream™ Air Blade™ Air Knife + Filter with Auto Drain + Regulator with Gauge
12006X	6" Gold Anodized Alum. X-Stream™ Air Blade™ Air Knife + Filter with Auto Drain + Regulator with Gauge
12009X	9" Gold Anodized Alum. X-Stream™ Air Blade™ Air Knife + Filter with Auto Drain + Regulator with Gauge
12012X	12" Gold Anodized Alum. X-Stream™ Air Blade™ Air Knife + Filter with Auto Drain + Regulator with Gauge
12018X	18" Gold Anodized Alum. X-Stream™ Air Blade™ Air Knife + Filter with Auto Drain + Regulator with Gauge
12024X	24" Gold Anodized Alum. X-Stream™ Air Blade™ Air Knife + Filter with Auto Drain + Regulator with Gauge
12030X	30" Gold Anodized Alum. X-Stream™ Air Blade™ Air Knife + Filter with Auto Drain + Regulator with Gauge
12036X	36" Gold Anodized Alum. X-Stream™ Air Blade™ Air Knife + Filter with Auto Drain + Regulator with Gauge
12042X	42" Gold Anodized Alum. X-Stream™ Air Blade™ Air Knife + Filter with Auto Drain + Regulator with Gauge
12048X	48" Gold Anodized Alum. X-Stream™ Air Blade™ Air Knife + Filter with Auto Drain + Regulator with Gauge
10054X	54" Gold Anodized Alum. X-Stream™ Air Blade™ Air Knife + Filter with Auto Drain + Regulator with Gauge

### Extra Stainless Steel Shims X-Stream™ Air Blade™ Air Knives (.002" or .050 mm Thick)

PART NO.	DESCRIPTION	PART NO.	DESCRIPTION
10102XS	2" Stainless Steel Shim	10124XS	24" Stainless Steel Shim
10103XS	3" Stainless Steel Shim	10130XS	30" Stainless Steel Shim
10106XS	6" Stainless Steel Shim	10136XS	36" Stainless Steel Shim
10109XS	9" Stainless Steel Shim	10142XS	42" Stainless Steel Shim
10112XS	12" Stainless Steel Shim	10148XS	48" Stainless Steel Shim
10118XS	18" Stainless Steel Shim		

**10900X:** Aluminum X-Stream™ Air Blade™ Air Knife Coupling Kit c/w 10 screws to couple together any aluminum Silent X-Stream™ Air Blade™ Air Knife from 6" & up.

**NOTE:** Plastic shims can wear out quickly in Air Knives if the air is not clean. Nex Flow™ uses ONLY stainless steel shims.





**Hard Anodized Aluminum X-Stream™ Full-Flow Air Blade™ Air Knives**

PART NO.	DESCRIPTION
10002XHA	2" Hard Anodized Alum. X-Stream™ Air Blade™ Air Knife Only
10003XHA	3" Hard Anodized Alum. X-Stream™ Air Blade™ Air Knife Only
10006XHA	6" Hard Anodized Alum. X-Stream™ Air Blade™ Air Knife Only
10009XHA	9" Hard Anodized Alum. X-Stream™ Air Blade™ Air Knife Only
10012XHA	12" Hard Anodized Alum. X-Stream™ Air Blade™ Air Knife Only
10018XHA	18" Hard Anodized Alum. X-Stream™ Air Blade™ Air Knife Only
10024XHA	24" Hard Anodized Alum. X-Stream™ Air Blade™ Air Knife Only
10030XHA	30" Hard Anodized Alum. X-Stream™ Air Blade™ Air Knife Only
10036XHA	36" Hard Anodized Alum. X-Stream™ Air Blade™ Air Knife Only
10042XHA	42" Hard Anodized Alum. X-Stream™ Air Blade™ Air Knife Only
10048XHA	48" Hard Anodized Alum. X-Stream™ Air Blade™ Air Knife Only
10054XHA	54" Hard Anodized Alum. X-Stream™ Air Blade™ Air Knife Only
11002XHA	2" Hard Anodized Alum. X-Stream™ Air Blade™ Air Knife plus Filter with Auto Drain
11003XHA	3" Hard Anodized Alum. X-Stream™ Air Blade™ Air Knife plus Filter with Auto Drain
11006XHA	6" Hard Anodized Alum. X-Stream™ Air Blade™ Air Knife plus Filter with Auto Drain
11009XHA	9" Hard Anodized Alum. X-Stream™ Air Blade™ Air Knife plus Filter with Auto Drain
11012XHA	12" Hard Anodized Alum. X-Stream™ Air Blade™ Air Knife plus Filter with Auto Drain
11018XHA	18" Hard Anodized Alum. X-Stream™ Air Blade™ Air Knife plus Filter with Auto Drain
11024XHA	24" Hard Anodized Alum. X-Stream™ Air Blade™ Air Knife plus Filter with Auto Drain
11030XHA	30" Hard Anodized Alum. X-Stream™ Air Blade™ Air Knife plus Filter with Auto Drain
11036XHA	36" Hard Anodized Alum. X-Stream™ Air Blade™ Air Knife plus Filter with Auto Drain
11042XHA	42" Hard Anodized Alum. X-Stream™ Air Blade™ Air Knife plus Filter with Auto Drain
11048XHA	48" Hard Anodized Alum. X-Stream™ Air Blade™ Air Knife plus Filter with Auto Drain
11054XHA	54" Hard Anodized Alum. X-Stream™ Air Blade™ Air Knife plus Filter with Auto Drain
12002XHA	2" Hard Anodized Alum. X-Stream™ Air Blade™ Air Knife + Filter with Auto Drain + Regulator with Gauge
12003XHA	3" Hard Anodized Alum. X-Stream™ Air Blade™ Air Knife + Filter with Auto Drain + Regulator with Gauge
12006XHA	6" Hard Anodized Alum. X-Stream™ Air Blade™ Air Knife + Filter with Auto Drain + Regulator with Gauge
12009XHA	9" Hard Anodized Alum. X-Stream™ Air Blade™ Air Knife + Filter with Auto Drain + Regulator with Gauge
12012XHA	12" Hard Anodized Alum. X-Stream™ Air Blade™ Air Knife + Filter with Auto Drain + Regulator with Gauge
12018XHA	18" Hard Anodized Alum. X-Stream™ Air Blade™ Air Knife + Filter with Auto Drain + Regulator with Gauge
12024XHA	24" Hard Anodized Alum. X-Stream™ Air Blade™ Air Knife + Filter with Auto Drain + Regulator with Gauge
12030XHA	30" Hard Anodized Alum. X-Stream™ Air Blade™ Air Knife + Filter with Auto Drain + Regulator with Gauge
12036XHA	36" Hard Anodized Alum. X-Stream™ Air Blade™ Air Knife + Filter with Auto Drain + Regulator with Gauge
12042XHA	42" Hard Anodized Alum. X-Stream™ Air Blade™ Air Knife + Filter with Auto Drain + Regulator with Gauge
12048XHA	48" Hard Anodized Alum. X-Stream™ Air Blade™ Air Knife + Filter with Auto Drain + Regulator with Gauge
10054XHA	54" Hard Anodized Alum. X-Stream™ Air Blade™ Air Knife + Filter with Auto Drain + Regulator with Gauge

**Extra Stainless Steel Shims X-Stream™ Air Blade™ Air Knives (.002" or .050 mm Thick)**

PART NO.	DESCRIPTION	PART NO.	DESCRIPTION
10102XS	2" Stainless Steel Shim	10124XS	24" Stainless Steel Shim
10103XS	3" Stainless Steel Shim	10130XS	30" Stainless Steel Shim
10106XS	6" Stainless Steel Shim	10136XS	36" Stainless Steel Shim
10109XS	9" Stainless Steel Shim	10142XS	42" Stainless Steel Shim
10112XS	12" Stainless Steel Shim	10148XS	48" Stainless Steel Shim
10118XS	18" Stainless Steel Shim		

**10900XHA:** Aluminum X-Stream™ Air Blade™ Air Knife Coupling Kit c/w 10 screws to couple together any aluminum Silent X-Stream™ Air Blade™ Air Knife from 6" & up.

**NOTE:** Plastic shims can wear out quickly in Air Knives if the air is not clean. Nex Flow™ uses ONLY stainless steel shims.

**STAINLESS STEEL X-STREAM™ AIR BLADE™ AIR KNIVES**

PART NO.	DESCRIPTION
10002XS	2" Stainless Steel X-Stream™ Full-Flow Air Blade™ Air Knife only
10003XS	3" Stainless Steel X-Stream™ Full-Flow Air Blade™ Air Knife only
10006XS	6" Stainless Steel X-Stream™ Full-Flow Air Blade™ Air Knife only
10009XS	9" Stainless Steel X-Stream™ Full-Flow Air Blade™ Air Knife only
10012XS	12" Stainless Steel X-Stream™ Full-Flow Air Blade™ Air Knife only
10018XS	18" Stainless Steel X-Stream™ Full-Flow Air Blade™ Air Knife only
10024XS	24" Stainless Steel X-Stream™ Full-Flow Air Blade™ Air Knife only
10030XS	30" Stainless Steel X-Stream™ Full-Flow Air Blade™ Air Knife only
10036XS	36" Stainless Steel X-Stream™ Full-Flow Air Blade™ Air Knife only
11002XS	2" Stainless Steel X-Stream™ Full-Flow Air Blade™ Air Knife plus Filter with Auto Drain
11003XS	3" Stainless Steel X-Stream™ Full-Flow Air Blade™ Air Knife plus Filter with Auto Drain
11006XS	6" Stainless Steel X-Stream™ Full-Flow Air Blade™ Air Knife plus Filter with Auto Drain
11009XS	9" Stainless Steel X-Stream™ Full-Flow Air Blade™ Air Knife plus Filter with Auto Drain
11012XS	12" Stainless Steel X-Stream™ Full-Flow Air Blade™ Air Knife plus Filter with Auto Drain
11018XS	18" Stainless Steel X-Stream™ Full-Flow Air Blade™ Air Knife plus Filter with Auto Drain
11024XS	24" Stainless Steel X-Stream™ Full-Flow Air Blade™ Air Knife plus Filter with Auto Drain
11030XS	30" Stainless Steel X-Stream™ Full-Flow Air Blade™ Air Knife plus Filter with Auto Drain
11036XS	36" Stainless Steel X-Stream™ Full-Flow Air Blade™ Air Knife plus Filter with Auto Drain
12002XS	2" Stainless Steel X-Stream™ Full-Flow Air Blade™ Air Knife + Filter with Auto Drain + Regulator with Gauge
12003XS	3" Stainless Steel X-Stream™ Full-Flow Air Blade™ Air Knife + Filter with Auto Drain + Regulator with Gauge
12006XS	6" Stainless Steel X-Stream™ Full-Flow Air Blade™ Air Knife + Filter with Auto Drain + Regulator with Gauge
12009XS	9" Stainless Steel X-Stream™ Full-Flow Air Blade™ Air Knife + Filter with Auto Drain + Regulator with Gauge
12012XS	12" Stainless Steel X-Stream™ Full-Flow Air Blade™ Air Knife + Filter with Auto Drain + Regulator with Gauge
12018XS	18" Stainless Steel X-Stream™ Full-Flow Air Blade™ Air Knife + Filter with Auto Drain + Regulator with Gauge
12024XS	24" Stainless Steel X-Stream™ Full-Flow Air Blade™ Air Knife + Filter with Auto Drain + Regulator with Gauge
12030XS	30" Stainless Steel X-Stream™ Full-Flow Air Blade™ Air Knife + Filter with Auto Drain + Regulator with Gauge
12036XS	36" Stainless Steel X-Stream™ Full-Flow Air Blade™ Air Knife + Filter with Auto Drain + Regulator with Gauge

**Extra Stainless Steel Shims X-Stream™ Air Blade™ Air Knives (.002" or .050 mm Thick)**

PART NO.	DESCRIPTION	PART NO.	DESCRIPTION
10102XS	2" Stainless Steel Shim	10118XS	18" Stainless Steel Shim
10103XS	3" Stainless Steel Shim	10124XS	24" Stainless Steel Shim
10106XS	6" Stainless Steel Shim	10130XS	30" Stainless Steel Shim
10109XS	9" Stainless Steel Shim	10136XS	36" Stainless Steel Shim
10112XS	12" Stainless Steel Shim		

**10900XS:** Stainless Steel X-Stream™ Air Blade™ Coupling Kit c/w 10 screws to couple together any Stainless Steel X-Stream™ Air Blade™ Air Knife from 6" and up.

**NOTE:** Plastic shims can wear out quickly in Air Knives if the air is not clean. Nex Flow™ uses ONLY stainless steel shims.



## CURVED X-STREAM™ AIR BLADE™ AIR KNIFE

New Fan Blowoff Continues the Gold Standard in Air Knife Curtain Blowoff Technology

The new X-Stream™ Curved Air Blade™ Air Knife is easy to mount and maintain. It reduces both compressed air consumption and noise levels. It's curved design produces an expanding, powerful blast of air in a fan shape to blowoff wide areas and can minimize air use using longer Air Knives.

Developed to address areas with limited space to blowoff a large area.

As with regular X-Stream™ Air Blade™ Air Knives, the X-Stream™ Curved Air Blade™ Air Knife produces a "laminar" flow of air along its curved face using the "Coanda" effect which entrains a large volume of air from the surrounding area along with a small amount of compressed air to produce an output flow up to 40 times.

### FEATURES:

Curved X-Stream™ Air Blade™ Air Knife is a full flow design with top or bottom mounting holes to easily attach to equipment. Rear air inlet port for compressed air. It is anodized for longer life.

- ▶ Made of anodized aluminum for long life
- ▶ Air inlet port on the back for a compact design and minimal air interference
- ▶ Airflow amplification of approximately 40:1 compared to 3:1 for drilled pipe or open jets and tubes
- ▶ Instant on-off with no moving parts, no electricity or explosion hazard

Inlet Pressure	Air Consumption SCFM per in. (SLPM per 25 mm) with standard .002"(.05 mm) gap	Air Consumption SCFM per in. (SLPM per 25 mm) with .004" (.10 mm) gap (shim added)
20 PSIG (1.4 BAR)	9.5 (269)	18.9 (535)
40 PSIG (2.8 BAR)	13.3 (377)	26.7 (756)
60 PSIG (4.1 BAR)	18.1 (513)	36.2 (1025)
80 PSIG (5.5 BAR)	22.0 (623)	44.0 (1246)
100 PSIG (6.9 BAR)	25.9 (734)	51.8 (1467)
120 PSIG (8.4 BAR)	30.6 (867)	61.2 (1733)

PART NO.	DESCRIPTION
19005X	Aluminium Curved X-Stream™ Air Blade™ Air Knife - 5" Radius
19105XS	Aluminium Curved X-Stream™ Air Blade™ Air Knife Stainless Steel Shim -5" Radius

(\* BSP Threads or Adaptors can be supplied depending on country location)



### BENEFITS:

- ▶ Built and designed for significantly longer life in difficult environments than many competing products.
- ▶ Easy to fit in small spaces.
- ▶ Energy reduction in compressed air use up to 90% and noise reductions of 15 dBA.
- ▶ Maintenance free with output easily controlled, safe to use.

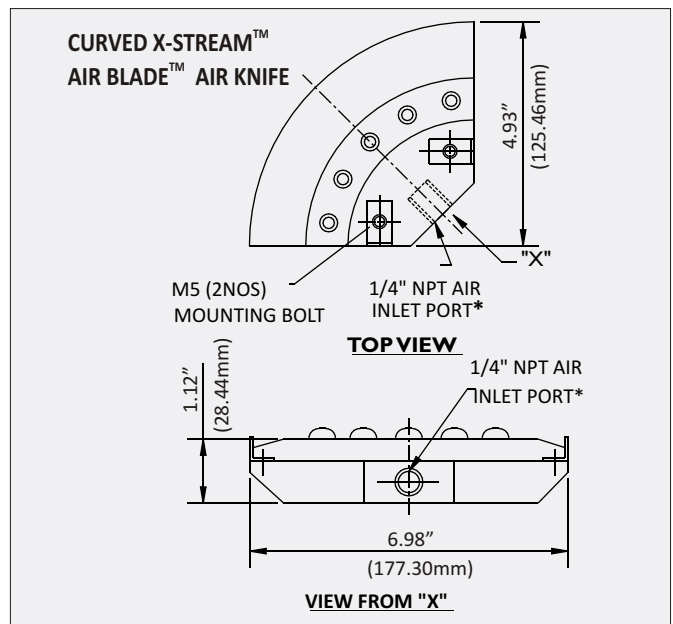

**AIR BLADE™ AIR KNIFE**



## STANDARD AIR BLADE™ AIR KNIFE

Blowoff, clean, cool and dry with a strong curtain of amplified airflow.

### WHAT ARE THEY - REASONS TO USE

Standard Air Blade™ Air Knife Blowoff System from Nex Flow™ is easy to mount and maintain, reducing both compressed air consumption and noise levels.

The Standard Air Blade™ Air Knife Blowoff System produces a “Laminar” flow of air along its length using the “Coanda” effect which “entrains” a large volume of air from the surrounding area along with the small amount of compressed air from the Air Blade™ Air knife to produce an output flow up to 30 times.

System payback on compressed air savings can be as soon as a few weeks in some applications.

It is less costly than the highly efficient and quiet Silent Air Blade™ Air Knife but produces a higher noise level. Still, it is popular for more heavy duty installations due to its greater bulk. In addition, it is excellent for some applications when mounted flush to a flat surface to create an extended air barrier along that surface.

### STANDARD AIR BLADE™ OR SILENT X-STREAM™ AIR KNIFE:

A Nex Flow™ applications engineer can best advise. Normally the X-Stream™ version is most efficient although the Standard would be lowest initial cost.

**NOTE:** Plastic shims can wear out quickly in Air Knives if the air is not clean. Nex Flow™ uses only stainless steel shims.



A Model 10018 Standard Air Blade™ Air Knife is used to blow scrap pieces and dirt from cellular phone parts after machining.

### STANDARD AIR BLADE™ AIR KNIFE FEATURES:

- ▶ No moving parts - anodized aluminum or stainless steel
- ▶ Compact design, simple, lightweight and portable
- ▶ Rugged design
- ▶ Full flow - air across entire length of Air Knife
- ▶ Air inlets at ends and back
- ▶ Driven by air not electricity
- ▶ Replaces drilled pipe and open jets or nozzles used for blowoff, cleaning, drying and cooling
- ▶ High airflow amplification
- ▶ Instant on-off, no electricity or explosion hazard

### STANDARD AIR BLADE™ AIR KNIFE BENEFITS:

- ▶ Longer life in difficult environments than competitive models
- ▶ Lower compressed air consumption than drilled pipe or rows of open jets and nozzles.
- ▶ Can be placed end to end for continuous airflow.
- ▶ Maintenance free with output easily controlled, safe to use.

### STANDARD AIR BLADE™ AIR KNIFE - HOW IT WORKS:

**Standard Air Blade™ Air Knife** - Compressed air enters the Air Knife at the rear (or end) ports at (A). Air is entrained at point (B) by the compressed air stream that leaves the Air Knife from a small gap. The entrained air follows the “Coanda” profile along the front face (C) that directs the air flow in a perfect straight line at 90 degrees to create a uniform sheet of air along the entire length of the Air Blade™ Air Knife. As the air leaves the Air Knife at point (D) the amplified air stream maximizes velocity and force is maximized as a well-defined sheet of laminar flow with minimal wind shear for reduced energy use in blowoff and cooling.

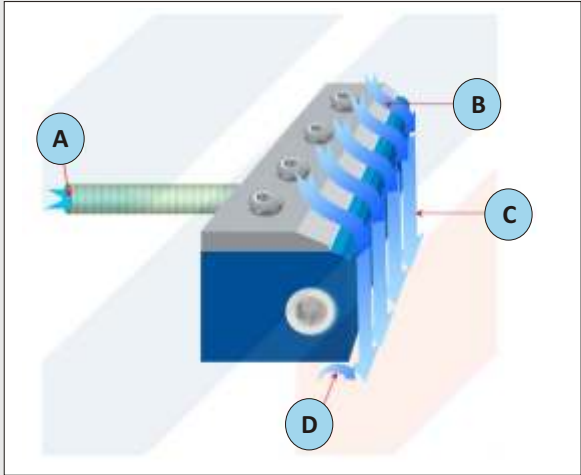

Standard Air Blade™ Air Knife is available in eight standard lengths in anodized aluminum and in seven lengths in stainless steel: 3" (76 mm), 6" (150 mm), 8" (203.2 mm) (not available in stainless), 12" (300 mm), 18" (457 mm), 24" (609.5 mm), 30" (761 mm), 36" (914 mm)

PART NO. (Aluminum & Stainless Steel)	AA Inches (mm)	A Inches (mm)	B Inches (mm)	C Inches (mm)	D Inches (mm)	E Inches (mm)	F Inches (mm)	G Inches (mm)	H Inches (mm)	Number of Rear Inlet (Side Inlets)
Model 10003 Aluminum	3"(76.2)	.625"(15.9)	N/A	N/A	2.375"(60.3)	0.344"(8.7)	1.50"(38.1)	N/A	N/A	1(2)
Model 10003S Stainless	3"(76.2)	.625"(15.9)	N/A	N/A	2.375"(60.3)	0.344"(8.7)	1.50"(38.1)	N/A	N/A	1(2)
Model 10006 Aluminum	6"(152)	1"(25.4)	N/A	N/A	5.0"(12.7)	0.344"(8.7)	3.0"(76.2)	N/A	N/A	1(2)
Model 10006S Stainless	6"(152)	1"(25.4)	N/A	N/A	5.0"(127)	0.344"(8.7)	3.0"(76.2)	N/A	N/A	1(2)
Model 10008 Aluminum	8"(203.2)	1.187"(30)	2.37"(60.2)	5.63"(143)	6.813"(162)	0.344"(8.7)	4.0"(101.6)	N/A	N/A	1(2)
Model 10008S Stainless	8"(203.2)	1.187"(30)	2.37"(60.2)	5.63"(143)	6.813"(162)	0.344"(8.7)	4.0"(101.6)	N/A	N/A	1(2)
Model 10012 Aluminum	12"(305)	1"(25.4)	3.1"(78.7)	8.9"(127)	11.0"(279)	0.344"(8.7)	6.0"(152)	N/S	N/S	1(2)
Model 10012S Stainless	12"(305)	1"(25.4)	3.1"(78.7)	8.9"(127)	11.0"(279)	0.344"(8.7)	6.0"(152)	N/A	N/A	1(2)
Model 10018 Aluminum	18"(457)	1.3"(33.4)	5.8"(148)	12.2"(310)	16.7"(424)	0.344"(8.7)	4.25"(108)	13.75"(349)	N/A	2(2)
Model 10018S Stainless	18"(457)	1.3"(33.4)	5.8"(148)	12.2"(310)	16.7"(424)	0.344"(8.7)	4.25"(108)	13.75"(349)	N/A	2(2)
Model 10024 Aluminum	24"(610)	1.3"(33.4)	4.2"(107)	19.8"(503)	22.7"(577)	0.344"(8.7)	7.3"(183)	16.7"(424)	12.0"(304.8)	2(2)
Model 10024S Stainless	24"(610)	1.3"(33.4)	4.2"(107)	19.8"(503)	22.7"(577)	0.344"(8.7)	7.3"(183)	16.7"(424)	12.0"(304.8)	2(2)
Model 10030 Aluminum	30"(761)	1.13"(28.7)	10.92"(277)	19.08"(485)	28.87"(733)	0.344"(8.7)	7.66"(195)	22.34"(567)	N/A	2(2)
Model 10030S Stainless	30"(761)	1.13"(28.7)	10.92"(277)	19.08"(485)	28.87"(733)	0.344"(8.7)	7.66"(195)	22.34"(567)	N/A	2(2)
Model 10036 Aluminum	36"(914)	1.09"(27.7)	10.75"(273)	18.75"(28.4)	34.92"(887)	0.344"(8.7)	7.53"(191)	28.47"(723)	18.8"(478)	2(2)
Model 10036S Stainless	36"(914)	1.09"(27.7)	10.75"(273)	18.75"(28.4)	34.92"(997)	0.344"(8.7)	7.53"(191)	28.47"(723)	18.8"(478)	2(2)

**AIR BLADE™ AIR KNIFE**

**STANDARD AIR BLADE™ AIR KNIFE**

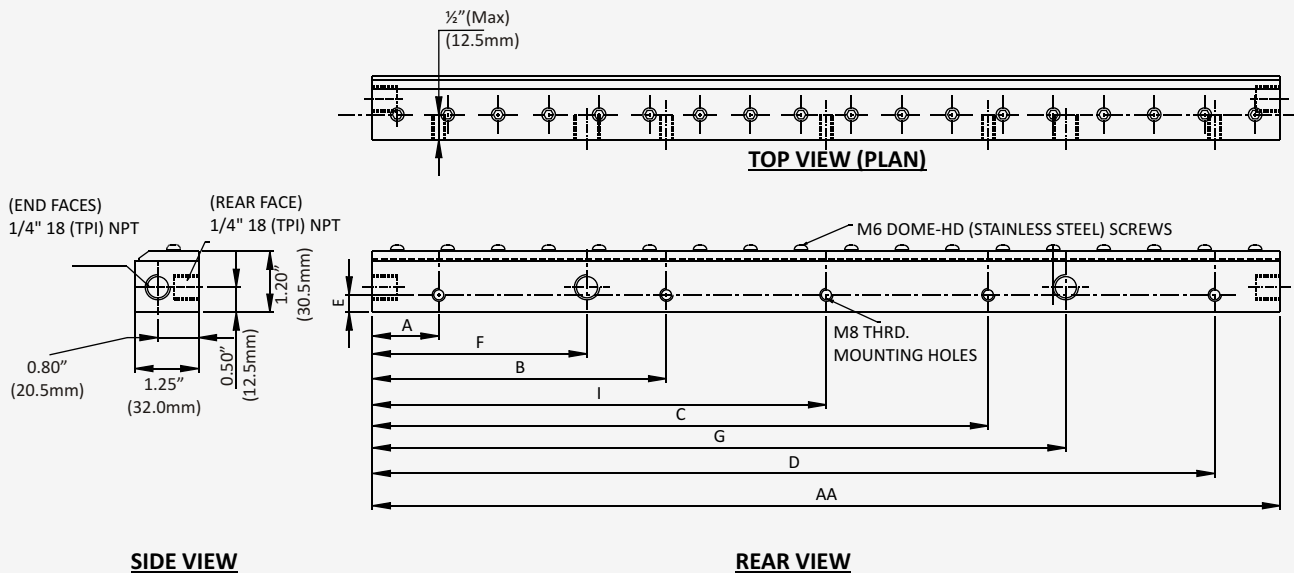

(\* BSP Threads or Adaptors can be supplied depending on country location)



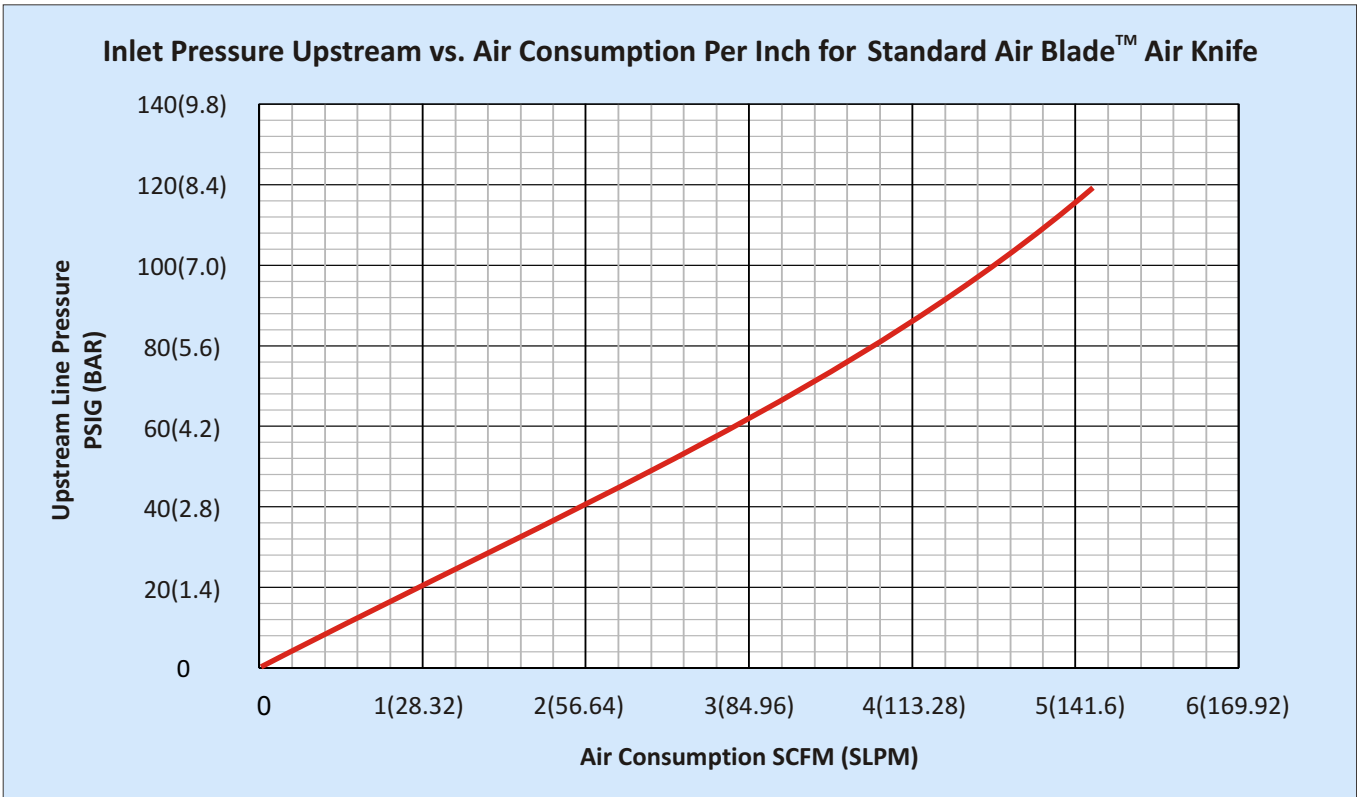

**NOTE:** Tests were performed using a 12" Model 10012 Standard Air Blade™ Air Knife

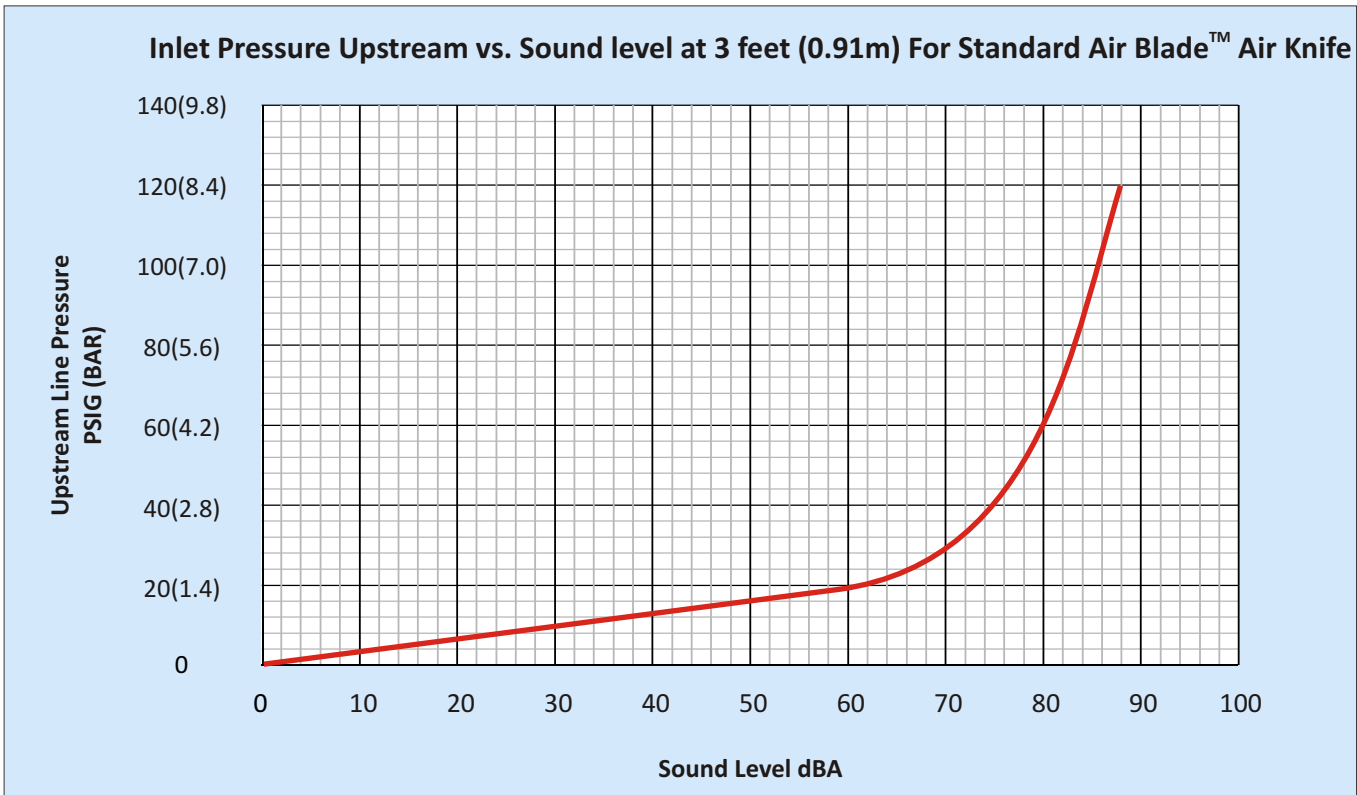

**NOTE:** Tests were performed using a 12" Model 10012 Standard Air Blade™ Air Knife



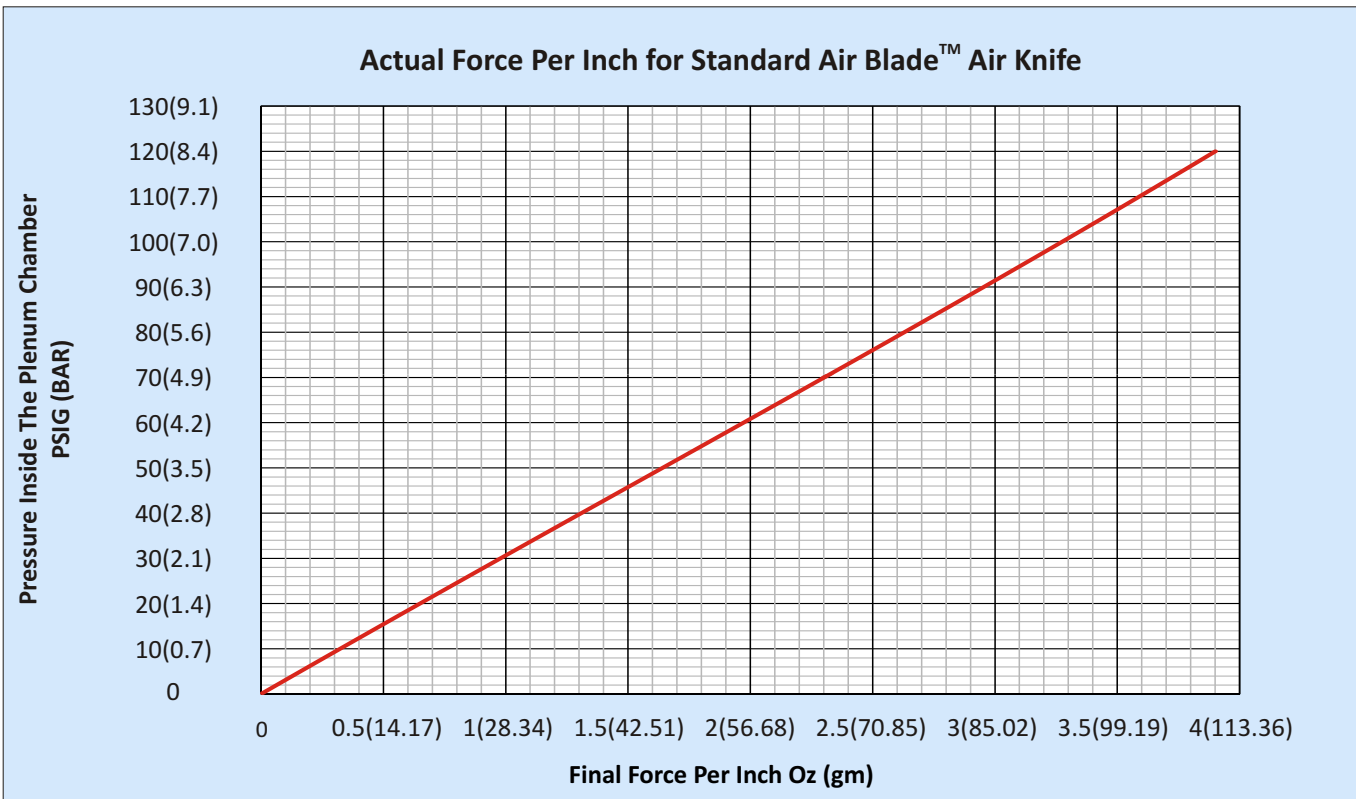

**NOTE:** Force per inch of Air Knife was based on tests done with a 12" Standard Air Blade™ Air Knife with a .002" (.050 mm) gap. Force was measured at a target 6" from the Air Knife.

Actual results may vary due to tolerance variations.  
 Estimate 30% more force with a .004" (.100 mm) gap.

**Force per Inch Explanation** - The pressure is measured at the chamber inside the Standard Air Blade™ Air Knife and not upstream. The force per inch is from tests using a Standard Air Blade™ Air Knife with the graph extrapolated for higher end pressures. Figures will vary with the length of the Air Knife. The longer the air knife, the less the chamber pressure will be and the force per inch will also decrease. This is because of the limited size and volume of the chamber and also because of the limited air inlet holes.

Estimated chamber pressure inside the Standard Air Blade™ Air Knife as a percentage of upstream line pressure can be reasonably estimated as follows. Size of air lines, upstream pressure, and piping configurations can cause a great variation in actual force produced and actual pressure formed in the chamber of the Air Knife. However, for general engineering applications the multiplication factors as shown in the graph "Multiplication Factors to Obtain Plenum Pressure for Standard Air Blade™ Air Knife" can be used to estimate the plenum pressure. Then you can obtain the force per inch from the Actual Force per inch graph.

- ▶ In general, the force per inch will be greater for shorter length Standard Air Blade™ Air Knives.
- ▶ If a particular application requires a greater force, it may be more useful to have several smaller length Air Knives than one larger one.

**EXAMPLE:**

Two (2) 12" Standard Air Blade™ Air Knives with a line pressure of 80 psig can be estimated to have a chamber pressure of 0.9 times the line pressure or  $0.9 \times 80 = 72$  psig.

The force per inch from the Force graph at 72 psig is about 2.2 Oz per inch for a total of  $2.4 \times 24 = 57.6$  Oz force

One (1) 24" Standard Air Blade™ Air Knife with a line pressure of 80 psig can be estimated to have a chamber pressure of 0.70 times the line pressure of  $0.7 \times 80 = 56$  psig.

The force per inch from the Force graph at 56 psig is  $1.8 \times 24 = 43$  Oz force.

**In most applications the single 24" Air Knife will work but in applications where force is critical, it can make sense to use several smaller Air Knives instead.**

**AIR BLADE™ AIR KNIFE**



**Multiplication Factors to Obtain Plenum Pressure for Standard Air Blade™ Air Knife**

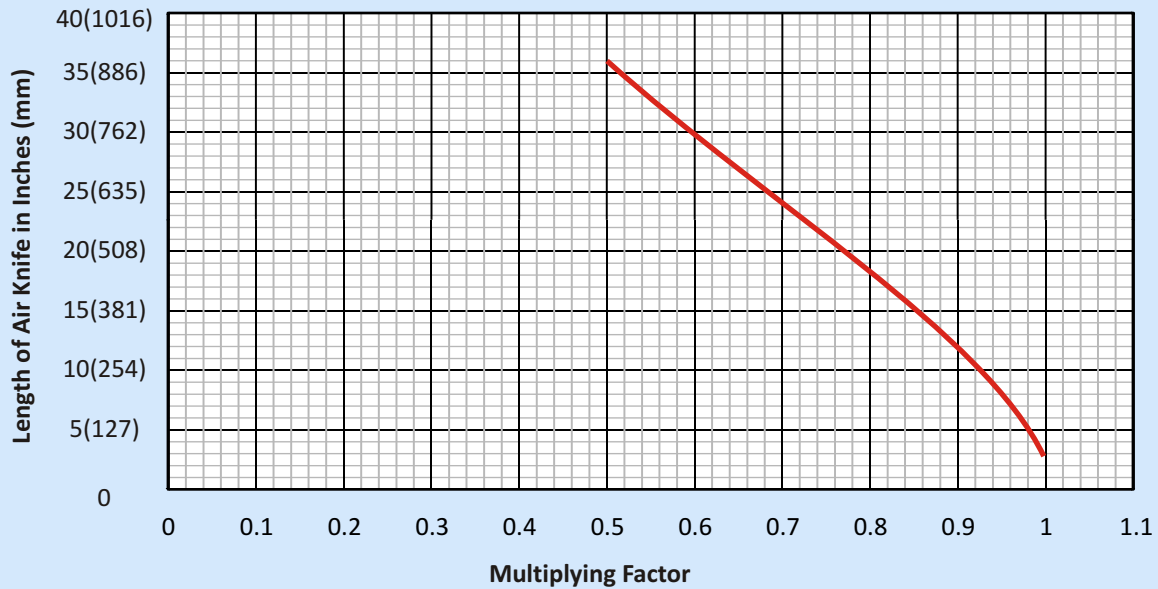

**NOTE:** These multipliers are based on having a large compressed air supply with air lines in the 1" range and with the location of use mid-plant. If the location is near the end of a long airline run, if there is a heavy use load and if air lines are small the multiplier can be reduced as much as 50%

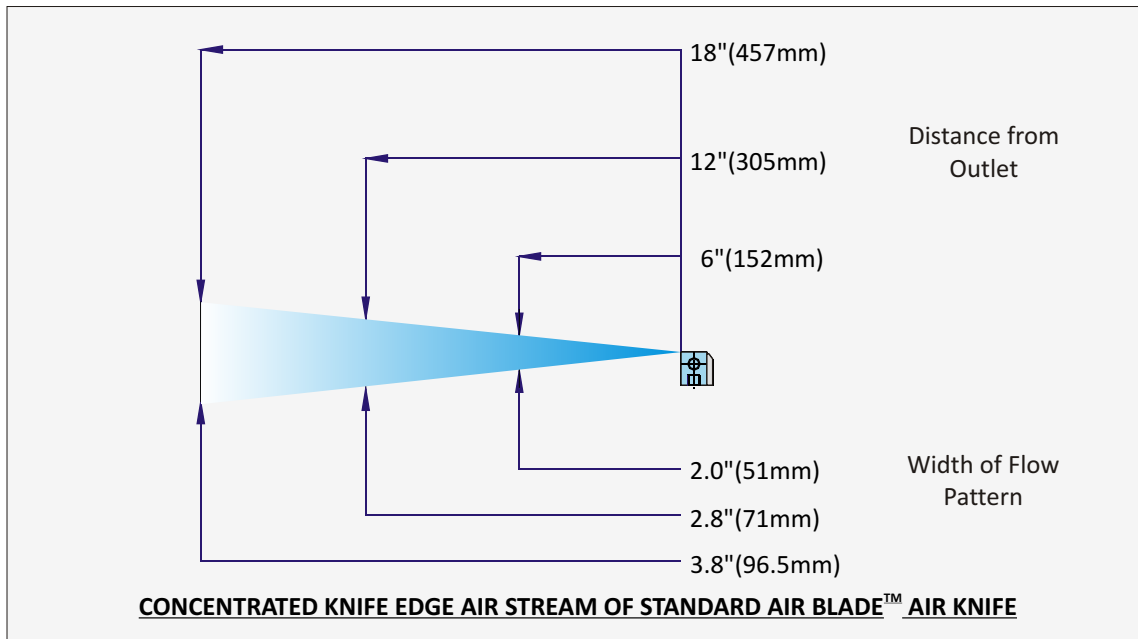

**NOTE:**

The performance of the X-Stream™ Air Blade™ Air Knife and the Standard Air Blade™ Air Knife will be relatively the same given "same" internal chamber conditions. However, due to design the X-Stream™ Air Blade™ will use about 15% "LESS" compressed air. This generally means less air line pressure drop and "higher" chamber pressures in an X-Stream™ Air Blade™ given the same application and therefore superior performance (as well as lower noise levels). The Standard Air Blade™ Air Knife however is lower cost has applications suited to its unique design.

**Force per Inch at Various Distance from Target at 80 PSIG Plenum Pressure for Standard Air Blade™ Air Knife**

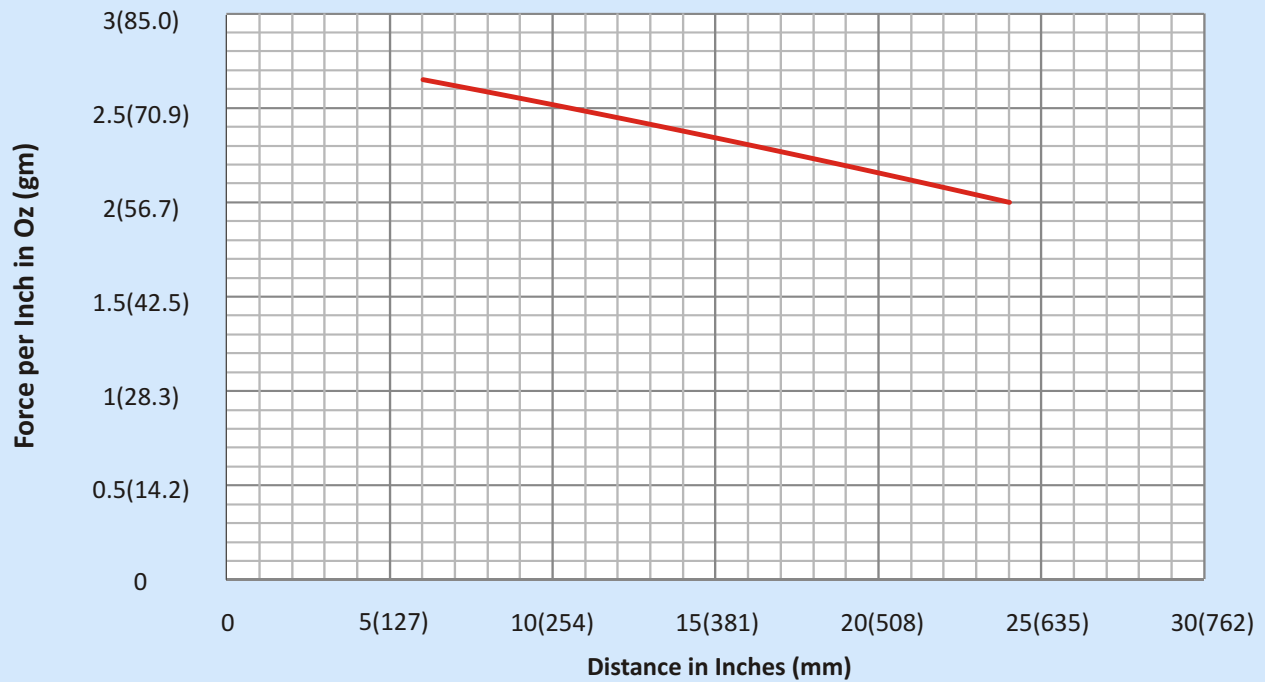

**NOTE:** Tests were performed using a 12" Model 10012 Standard Air Blade™ Air Knife

**AIR BLADE™ AIR KNIFE**

A Model 10003 3" Standard Air Blade™ Air Knife is mounted such that the surface of the Air Knife is flush with the surface of a camera lens. The air flows along the surface of the Air Knife and continues along the lens due to a boundary layer effect that provides a laminar "barrier" to the dirty environmental air, keeping the lens clean and dry.

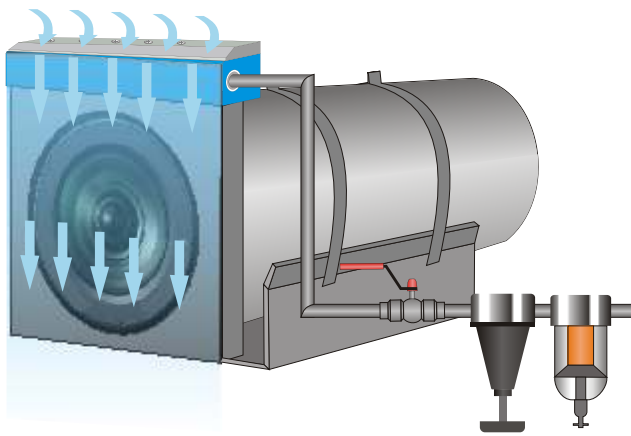

Two Model 10012 Standard Air Blade™ Air Knives are installed on a duct (One on top, One on bottom) to draw in waste fumes & exhaust. The air leaving the Air Knives hug the inside wall creating an excellent vacuum inside the duct.

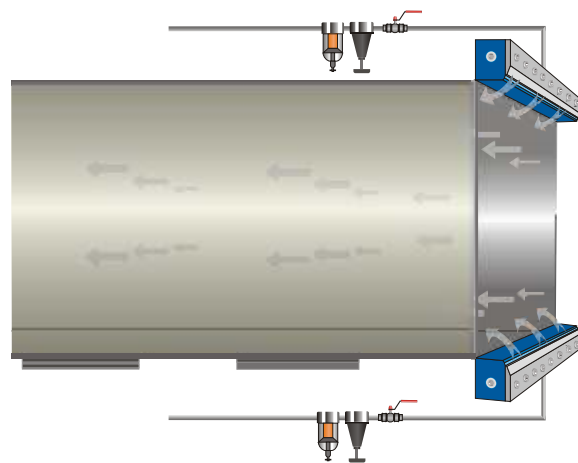

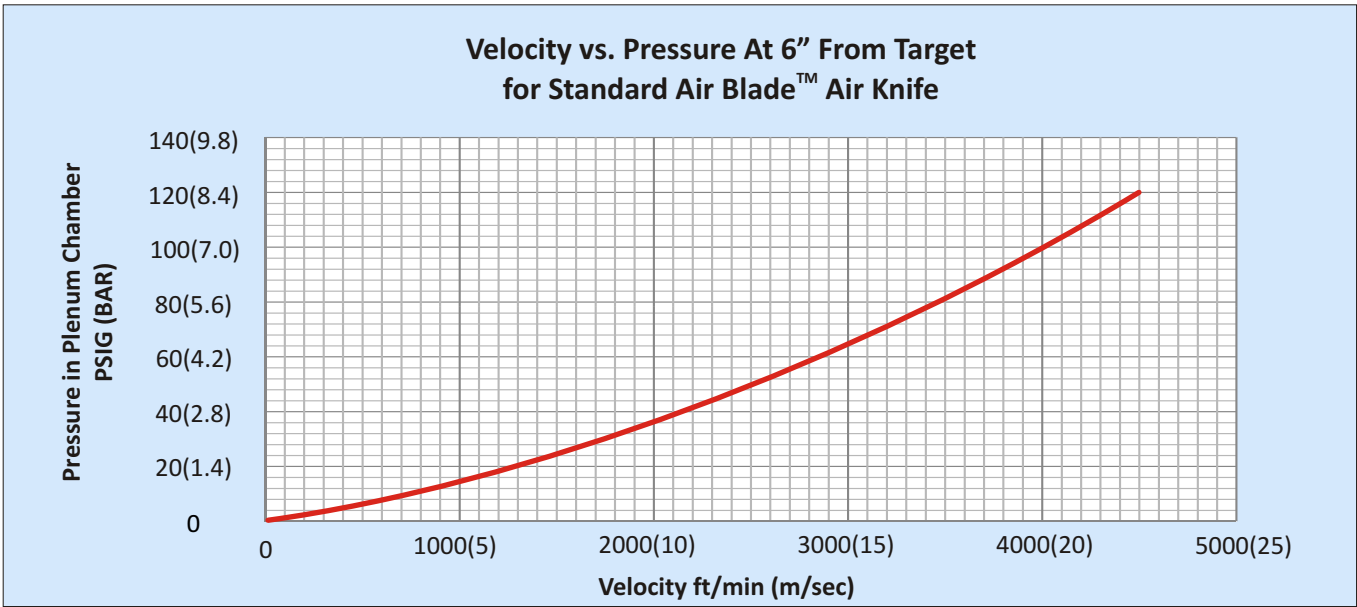

**NOTE:** Tests were performed using a 12" Model 10012 Standard Air Blade™ Air Knife

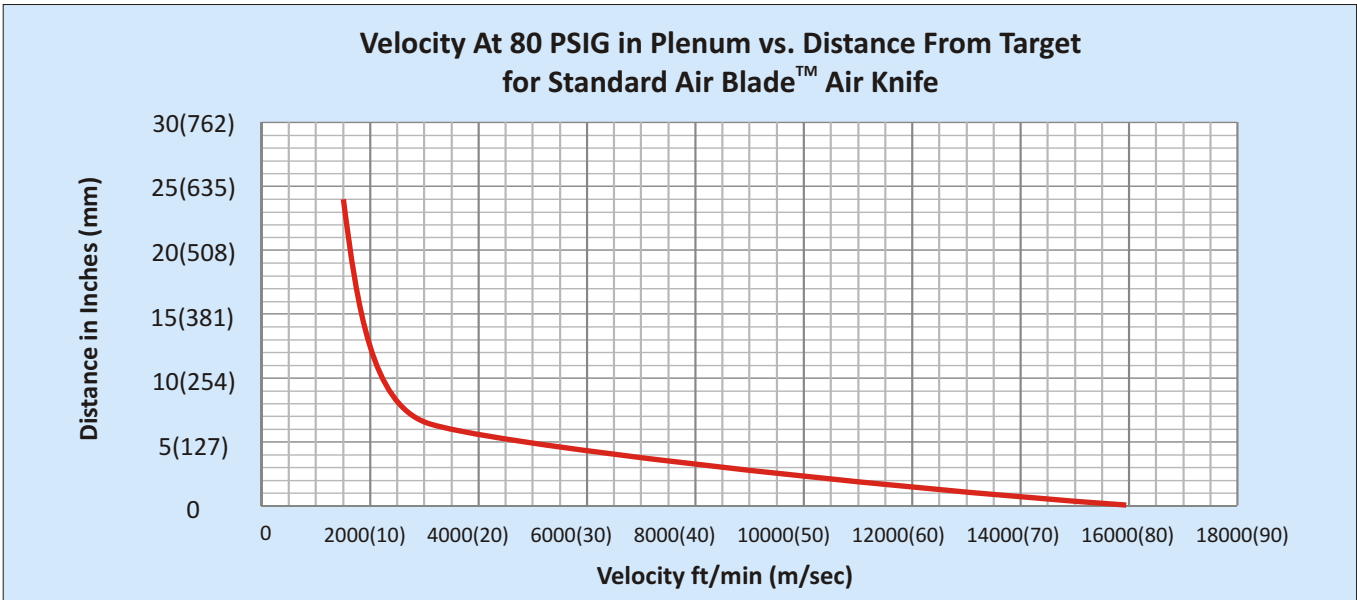

**NOTE:** Tests were performed using a 12" Model 10012 Standard Air Blade™ Air Knife

Velocity is important in that it can determine the cooling effect and to some extent is related to the blowoff force. Velocity will vary significantly depending on the temperature of the ambient air the hotter the air, the greater the velocity (and the greater the amplification of air flow) so velocity figures at best are an approximation. As air is entrained, the flow increases and as the flow increases the velocity must come down.

The velocity at the exit of the Standard Air Blade™ Air Knife is obviously the highest but the figure is of no real value as once the surrounding air is entrained, the velocity drops dramatically. (Be very wary of extremely high velocity claims downstream of any Air Knife). The figures we provide can be verified with a velocity meter. There will be variations in measurement due to air pressure, and atmospheric conditions. The velocity is, among these other things dependent on the chamber pressure. That pressure in turn depends upon pipe size, pressure drops in the system, distance from the compressor station to the use point, and many other factors. (See previous pages referring to force approximations and multipliers to estimate chamber pressure).





**CALCULATING AIR SAVINGS**

The chart below shows the air consumption at different pressures of various hole sizes compare to the air consumption per inch of an Standard Air Blade™ Air Knife. To obtain the air consumption of drilled holes in pipe determine the size of the holes and multiply the air loss by the number of holes over the length.

The air usage of the X-Stream™ Air Blade™ Air Knife is per inch - just multiply the figure from the chart by the length of the Air Blade™ Air Knife.

**EXAMPLE:**

Assume an existing blowoff of a 24" long pipe with 3/32" holes spaced 3/4" inches apart for a total of 32 holes. At 80 PSIG from the graph each hole consumes about 9.4 SCFM for a total of 32 X 9.4 = 300.8 SCFM

At 80 PSIG a 24" Standard™ Air Blade™ Air Knife consumes 24 X 3.8 SCFM/inch = 91.2 SCFM

Compressed air saved is 300.8 - 91.2 = 209.6 SCFM

Using actual air costs if known (or assuming a reasonable cost of \$.30 US per 1000 cubic feet) the dollars saved is 209.6 X 60 X 0.30/1000 = \$3.77/hr or assuming an 2000 hour working year = \$7450.00 SAVED PER YEAR

**Diameter of hole in pipe in Inches (mm) and air consumption per Inch (25.4mm) of Air Knife.**

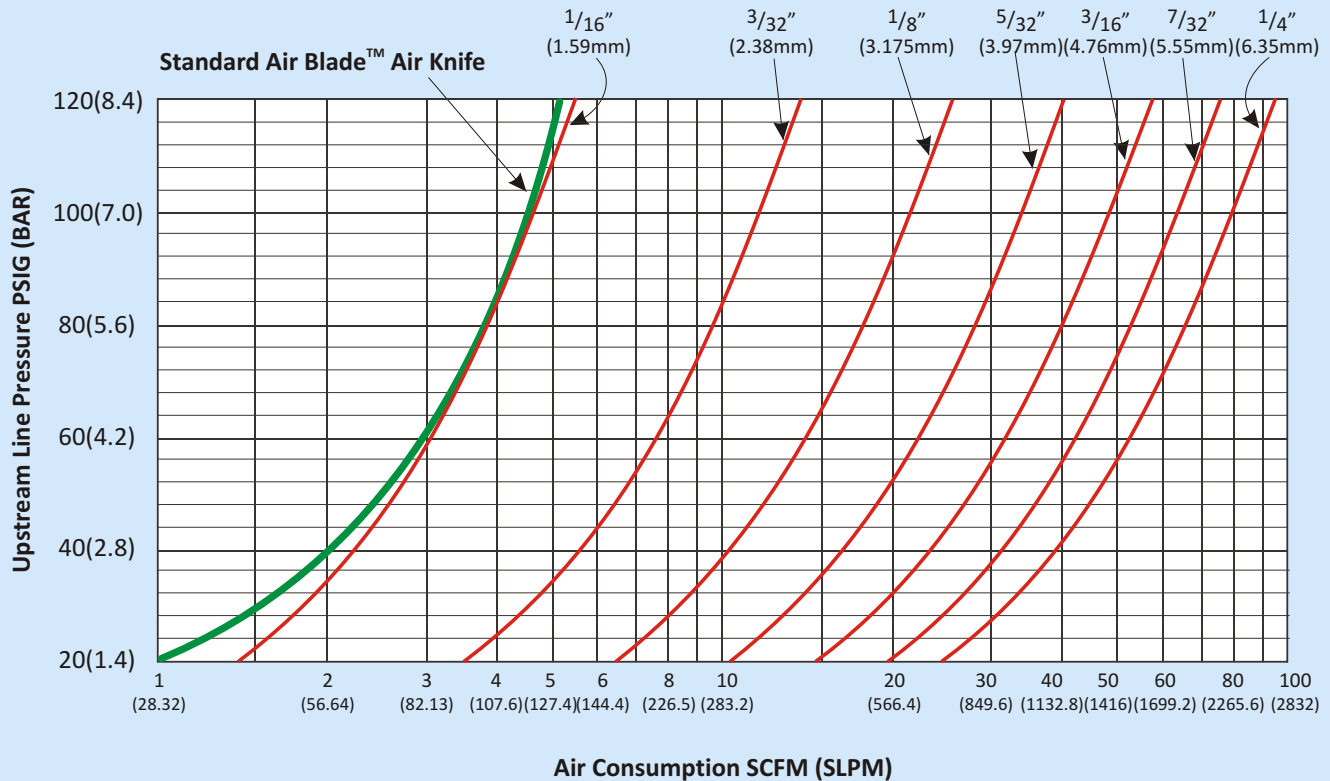

**AIR BLADE™ AIR KNIFE**



**Aluminum Standard Air Blade™ Air Knife**

PART NO.	DESCRIPTION
10003	3" Aluminum Standard Full-Flow Air Blade™ Air Knife Only
10006	6" Aluminum Standard Full-Flow Air Blade™ Air Knife Only
10008	8" Aluminum Standard Full-Flow Air Blade™ Air Knife Only
10012	12" Aluminum Standard Full-Flow Air Blade™ Air Knife Only
10018	18" Aluminum Standard Full-Flow Air Blade™ Air Knife Only
10024	24" Aluminum Standard Full-Flow Air Blade™ Air Knife Only
10030	30" Aluminum Standard Full-Flow Air Blade™ Air Knife Only
10036	36" Aluminum Standard Full-Flow Air Blade™ Air Knife Only
11003	3" Aluminum Standard Full-Flow Air Blade™ Air Knife plus Filter with Auto Drain
11006	6" Aluminum Standard Full-Flow Air Blade™ Air Knife plus Filter with Auto Drain
11008	8" Aluminum Standard Full-Flow Air Blade™ Air Knife plus Filter with Auto Drain
11012	12" Aluminum Standard Full-Flow Air Blade™ Air Knife plus Filter with Auto Drain
11018	18" Aluminum Standard Full-Flow Air Blade™ Air Knife plus Filter with Auto Drain
11024	24" Aluminum Standard Full-Flow Air Blade™ Air Knife plus Filter with Auto Drain
11030	30" Aluminum Standard Full-Flow Air Blade™ Air Knife plus Filter with Auto Drain
11036	36" Aluminum Standard Full-Flow Air Blade™ Air Knife plus Filter with Auto Drain
12003	3" Aluminum Standard Full-Flow Air Blade™ Air Knife + Filter with Auto Drain + Reg. With gauge
12006	6" Aluminum Standard Full-Flow Air Blade™ Air Knife + Filter with Auto Drain + Reg. With gauge
12008	8" Aluminum Standard Full-Flow Air Blade™ Air Knife + Filter with Auto Drain + Reg. with gauge
12012	12" Aluminum Standard Full-Flow Air Blade™ Air Knife + Filter with Auto Drain + Reg. With gauge
12018	18" Aluminum Standard Full-Flow Air Blade™ Air Knife + Filter with Auto Drain + Reg. with gauge
12024	24" Aluminum Standard Full-Flow Air Blade™ Air Knife + Filter with Auto Drain + Reg. with gauge
12030	30" Aluminum Standard Full-Flow Air Blade™ Air Knife + Filter with Auto Drain + Reg. with gauge
12036	36" Aluminum Standard Full-Flow Air Blade™ + Filter with Auto Drain + Regulator with gauge

**Extra Stainless Steel Shims Standard Air Blade™ Air Knife (.002" or .050 mm Thick)**

PART NO.	DESCRIPTION	PART NO.	DESCRIPTION
10103S	3" Stainless Steel Shim	10118S	18" Stainless Steel Shim
10106S	6" Stainless Steel Shim	10124S	24" Stainless Steel Shim
10108S	8" Stainless Steel Shim	10130S	30" Stainless Steel Shim
10112S	12" Stainless Steel Shim	10136S	36" Stainless Steel Shim

**NOTE:** Plastic shims can wear out quickly in Air Knives if the air is not clean. Nex Flow™ uses ONLY stainless steel shims.



**Stainless Steel Standard Air Blade™ Air Knife**

PART NO.	DESCRIPTION
10003S	3" Stainless Steel Standard Full-Flow Air Blade™ Only
10006S	6" Stainless Steel Standard Full-Flow Air Blade™ Only
10012S	12" Stainless Steel Standard Full-Flow Air Blade™ Only
10018S	18" Stainless Steel Standard Full-Flow Air Blade™ Only
10024S	24" Stainless Steel Standard Full-Flow Air Blade™ Only
10030S	30" Stainless Steel Standard Full-Flow Air Blade™ Only
10036S	36" Stainless Steel Standard Full-Flow Air Blade™ Only
11003S	3" Stainless Steel Standard Full-Flow Air Blade™ plus Filter with Auto Drain
11006S	6" Stainless Steel Standard Full-Flow Air Blade™ plus Filter with Auto Drain
11012S	12" Stainless Steel Standard Full-Flow Air Blade™ plus Filter with Auto Drain
11018S	18" Stainless Steel Standard Full-Flow Air Blade™ plus Filter with Auto Drain
11024S	24" Stainless Steel Standard Full-Flow Air Blade™ plus Filter with Auto Drain
11030S	30" Stainless Steel Standard Full-Flow Air Blade™ plus Filter with Auto Drain
11036S	36" Stainless Steel Standard Full-Flow Air Blade™ plus Filter with Auto Drain
12003S	3" Stainless Steel Standard Full-Flow Air Blade™ + Filter with Auto Drain + Regulator with gauge
12006S	6" Stainless Steel Standard Full-Flow Air Blade™ + Filter with Auto Drain + Regulator
12012S	12" Stainless Steel Standard Full-Flow Air Blade™ + Filter with Auto Drain + Regulator with gauge
12018S	18" Stainless Steel Standard Full-Flow Air Blade™ + Filter with Auto Drain + Regulator with gauge
12024S	24" Stainless Steel Standard Full-Flow Air Blade™ + Filter with Auto Drain + Regulator with gauge
12030S	30" Stainless Steel Standard Full-Flow Air Blade™ + Filter with Auto Drain + Regulator with gauge
12036S	36" Stainless Steel Standard Full-Flow Air Blade™ + Filter with Auto Drain + Regulator with gauge

**Extra Stainless Steel Shims for Standard Air Blade™ Air Knife (.002" or .050 mm Thick)**

PART NO.	DESCRIPTION
10103S	3" Stainless Steel Shim
10106S	6" Stainless Steel Shim
10112S	12" Stainless Steel Shim
10118S	18" Stainless Steel Shim

PART NO.	DESCRIPTION
10124S	24" Stainless Steel Shim
10130S	30" Stainless Steel Shim
10136S	36" Stainless Steel Shim

**NOTE:** Plastic shims can wear out quickly in Air Knives if the air is not clean. Nex Flow™ uses ONLY stainless steel shims.