



THE  
SPRAY NOZZLE  
PEOPLE

Version 3.2015

# Uni-Spray Systems Inc.



Uni-Spray Systems high quality  
solutions to spraying and  
pretreatment industries

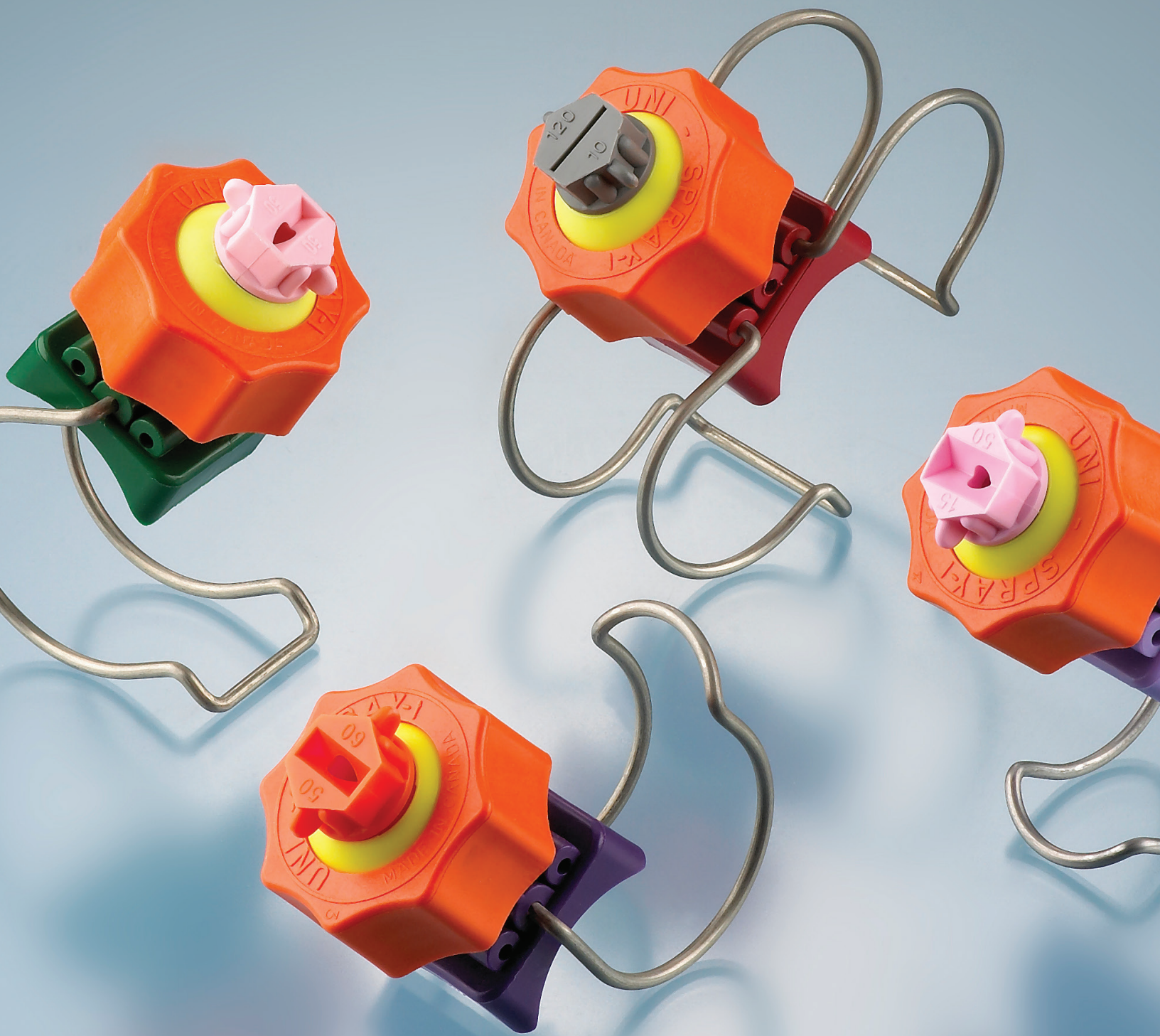

# UNI-SPRAY QUICK-RELEASE NOZZLES, COUPLERS AND PIPE SYSTEMS FOR THE PRETREATMENT INDUSTRY.

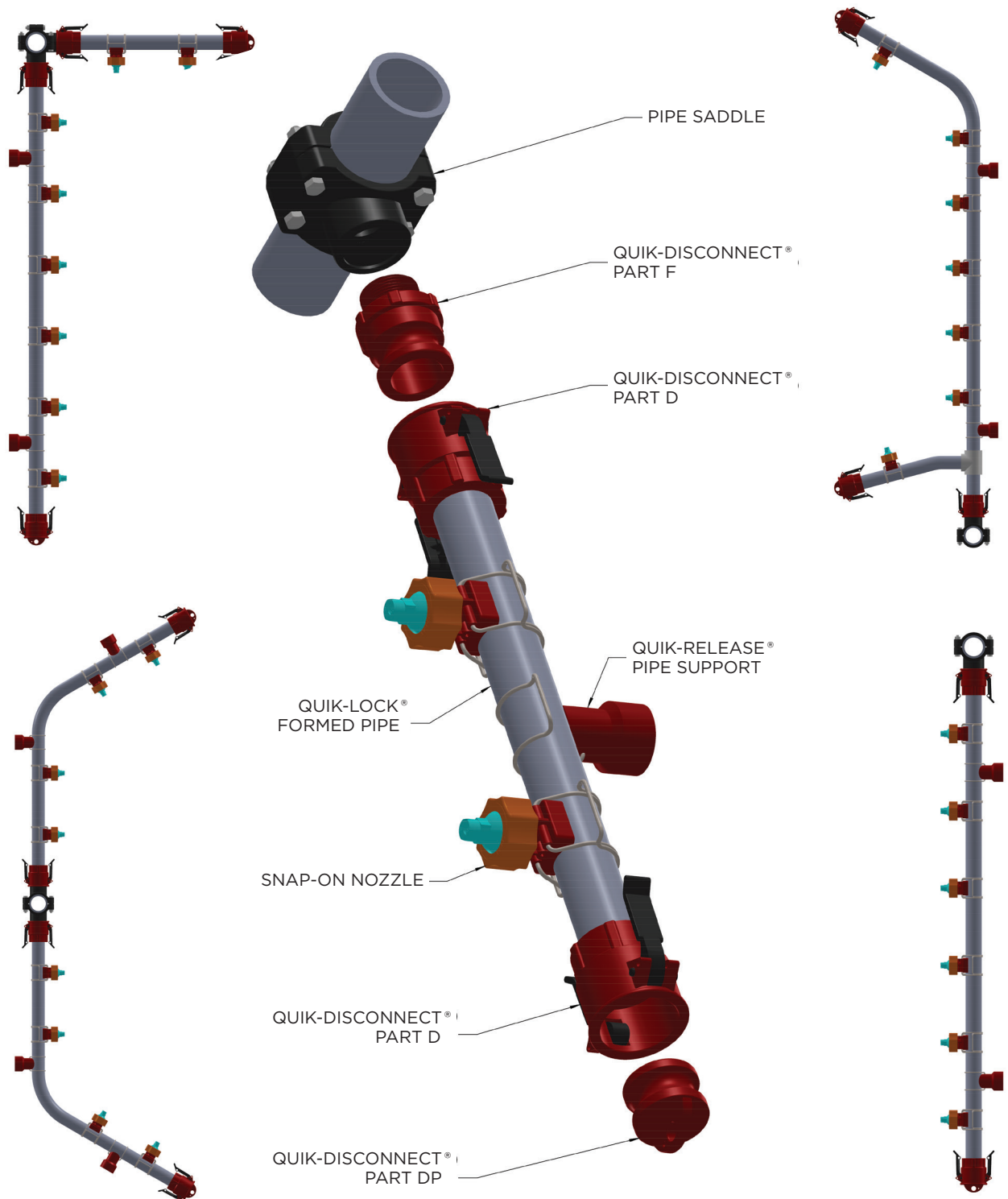

DESIGNED FOR YOUR APPLICATION

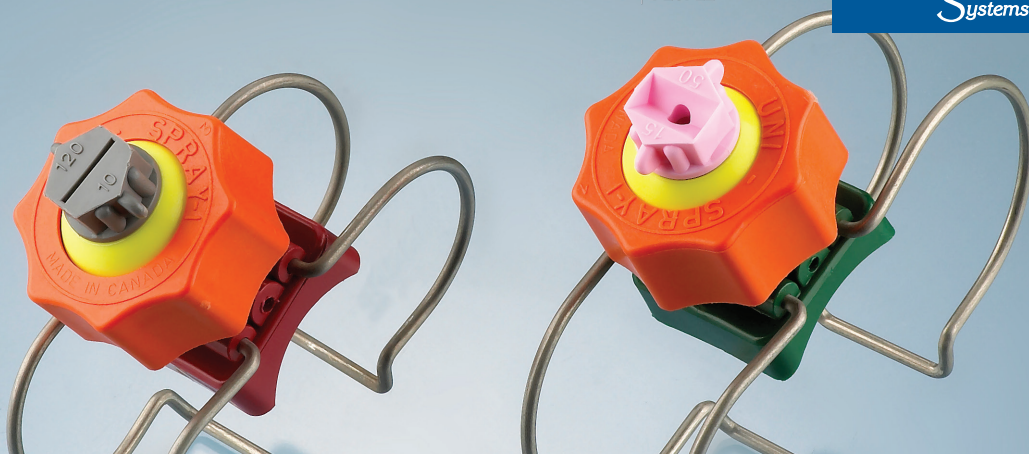

## CONTENTS

3	<b>NOZZLES</b>	27	<b>PIPE SADDLES</b>
4	Mark 1 Nozzle, Technical Details	28	Saddle Assembly Instructions
5	Mark 1 Nozzle, Ordering Information	29	Saddle Dimensions
6	Mark 2 Nozzle, Technical Details		
7	Mark 2 Nozzle, Ordering Information	30	<b>RISER SUPPORTS</b>
8	Mark 3 Nozzle, Technical Details		
9	Mark 3 Nozzle, Ordering Information	32	<b>EDUCTORS</b>
10	Spray Coverage	33	Eductor Capacities
11	Flat Spray Tip Selection Data		
12	Quick-Change Tip Information Sheet	34	<b>RISER SYSTEMS</b>
13	Quick-Change Tip Selection Data	35	Riser Selection
14	Hollow Cone/Full Cone Tip Selection Data & Threaded Ball Selection Data	38	Riser Worksheet Instructions
15	Spray Nozzle Components	39	Riser Worksheet Example
18	Nozzle Pressure & Flow	40	Nozzle Angle Selection and Spacing
19	<b>QUIK-DISCONNECTS</b>		
20	Q.D. Selection Sheet		
21	Q.D. Ordering Information		
22	Q.D. Dimensions		
24	Q.D. Replacement Parts		
25	Q.D. Pipe-end Separation Distances		

## QUICK-RELEASE NOZZLE ASSEMBLIES

- ◀ Uni-Spray Nozzles are injection molded from custom-blended polypropylene, a cost-effective material that is corrosion and heat-resistant and impervious to most chemicals.
- ◀ The tip design resists clogging and buildup due to its smooth shape and low coefficient of friction.
- ◀ A wide variety of Uni-Spray Clamp-On Nozzles are available to suit your application and are colour-coded for easy identification (see table below).
- ◀ All nozzles are available with a Single-Spring or an optional Double-Spring configuration for pressures over 4.0 bar.
- ◀ All nozzles are available in three spigot sizes, to fit 14 mm, 17 mm and 19 mm diameter holes in the riser.

### Mark 1 Adjustable Nozzle Assembly

- ◀ Permits directional adjustment of the nozzle tip anywhere within a 45° included angle.
- ◀ Interchangeable Nozzle Tips are available in Full Cone, Hollow Cone or Flat Spray styles with various combinations of spray angle and flow rate.
- ◀ The Mark 1 is also available with a Threaded Ball Connection in 1/8", 1/4", 3/8" and 1/2" BSPT, allowing the use of any threaded plastic, brass or steel nozzle.
- ◀ Refer to pages 4 and 5 for Assembly Details and Ordering Information, pages 11 and 14 for Tip Selection and page 15 for Replacement Parts.

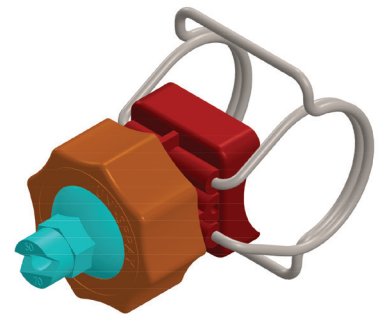

### Mark 2 Fixed Nozzle Adapter

- ◀ Offers female threaded connections in 1/8", 1/4", 3/8" and 1/2" BSPT threads, allowing the use of any threaded plastic, brass or steel nozzle.
- ◀ See pages 6 and 7 for Assembly Details and Ordering Information.

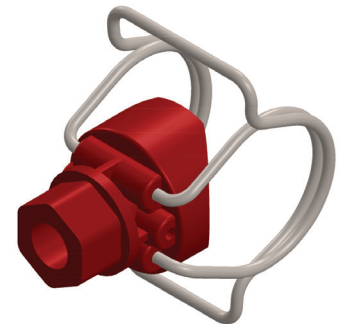

### Available Sizes

The Mark 1 and Mark 2 Nozzle Assemblies are colour-coded for convenient identification, and are available to fit the following pipe sizes:

(mm)	Reg. Spigot (17 mm)	Sm. Spigot (14 mm)	Lg. Spigot (20 mm)
25 mm	Blue	Lt Blue	Lt Blue
32 mm	Red	Pink	Pink
40 mm	Purple	Mauve	Mauve
50 mm	Green	Lime green	Lime Green



## FEATURES

- Inexpensive
- Corrosion resistant
- Impervious to most chemicals
- Good heat resistance
- Injection-molded from custom-blended polypropylene
- Standard with Single Spring Clamp
- Optional Double Spring Clamps for pressures over 4.0 bar
- Resists clogging
- Directional adjustment of nozzle tip anywhere within 45°
- Tips available in Full Cone, Hollow Cone or Flat Spray configurations
- Tips available with Threaded Ball Connection in 1/8", 1/4", 3/8" and 1/2" BSPT threads
- Nozzle bodies available in three spigot sizes to fit either 17 mm, 21 mm or 14 mm diameter holes on the riser

## Mark 1 Adjustable Nozzle Assembly

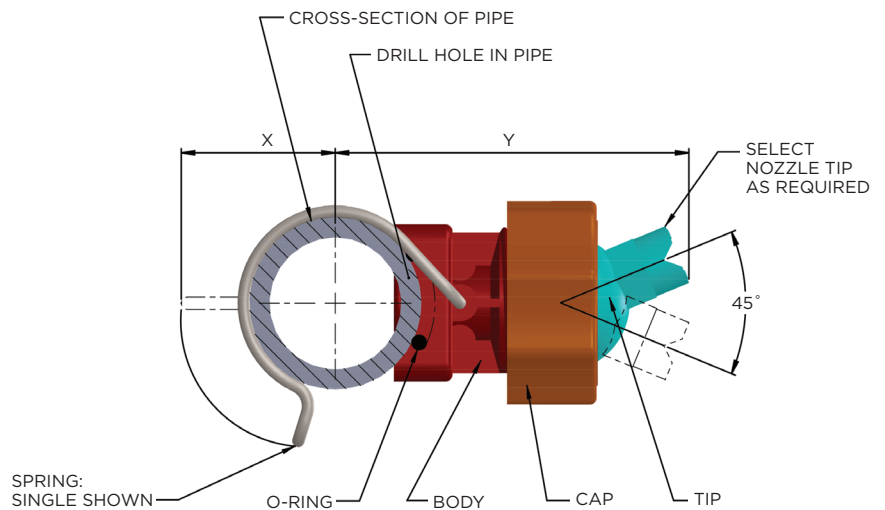

## MAJOR DIMENSIONS

Pipe (mm)	X	Y	Reg. Spigot 17mm	Sm. Spigot 14mm	Reg. Spigot 20mm	Reg. Spigot 10mm
19 mm	30	79	N/A	N/A	N/A	Black
25 mm	43	81	Blue	Lt. Blue	Lt. Blue	N/A
32 mm	48	87	Red	Pink	Pink	N/A
40 mm	51	90	Purple	Mauve	Mauve	N/A
50 mm	57	95	Green	Lime Green	Lime Green	N/A

Also available with Double Springs for pressures from 4 to 10 bar.

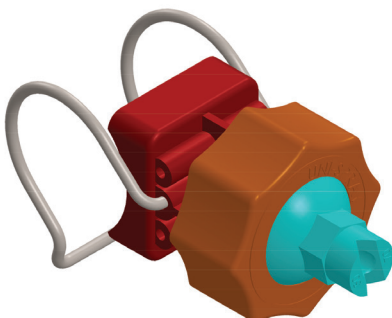

*Established in 1987, Uni-Spray Systems Inc. is a global leader in nozzle pretreatment systems and product innovation.*

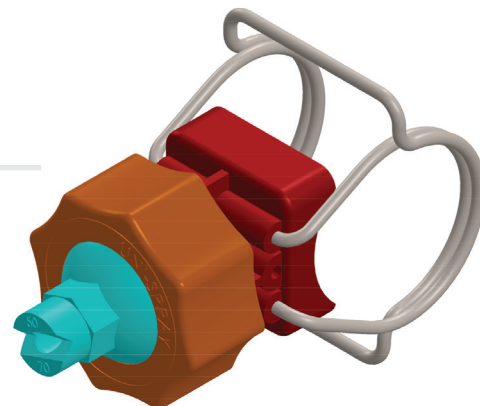

## Mark 1 Adjustable Nozzle Assembly ORDERING INSTRUCTIONS

### How to order a Mark 1 Adjustable Nozzle Assembly:

The complete Part Number tells us exactly what assembly you want.

For example, let's say that you want to order a Mark 1 Adjustable Nozzle Assembly to fit onto a 32 mm (1 1/4") pipe, with a Single Spring, and with a 65° Flat Spray Nozzle Tip that will deliver 13 lpm at 2.0 bar:

#### STEP 1

The Part Number begins with UNI, followed by the pipe size:

UNI 75 = 19mm (3/4") pipe  
 UNI 100= 25 mm (1") pipe  
 UNI 125= 32 mm (1 1/4") pipe  
 UNI 150= 40 mm (1 1/2") pipe  
 UNI 200= 50 mm (2") pipe

So in our example, we would have so far

UNI 125

#### STEP 2

Select a Nozzle Tip from page 11 and add the Tip Number to the Part Number. In our example we now have

UNI 125 6540

Note that the 'UNI' in front of the Tip Number on page 11 is dropped when the Tip Number is incorporated into the Assembly Part Number.

#### STEP 3

Add M1 to denote the Style, which is standard with Single Spring. If you wanted a Double Spring, the Style would be M1 D.

So in our example, we end up with:

UNI 125 6540 M1

**Note:** Our standard Nozzle Assemblies are designed with spigots to fit risers with 17 mm diameter holes. We also manufacture assemblies with smaller spigots for 14 mm diameter holes and larger spigots for 20 mm holes. To specify the 14 mm spigots, simply change the 'UNI' in the part number to 'SS' for Small Spigot or LS for Large Spigot. For a Small Spigot, using the example above, the part number would become: SS 150 6540 M1.



### FEATURES

- Inexpensive
- Corrosion resistant
- Impervious to most chemicals
- Good heat resistance
- Injection-molded from custom-blended polypropylene
- Standard with Single Spring Clamp
- Optional Double Spring Clamps for pressures over 4.0 bar
- Available with threaded connection in 1/8", 1/4", 3/8" and 1/2" BSPT threads
- Nozzle bodies fit 17 mm diameter holes on the riser

### Mark 2 Fixed Nozzle Adapter

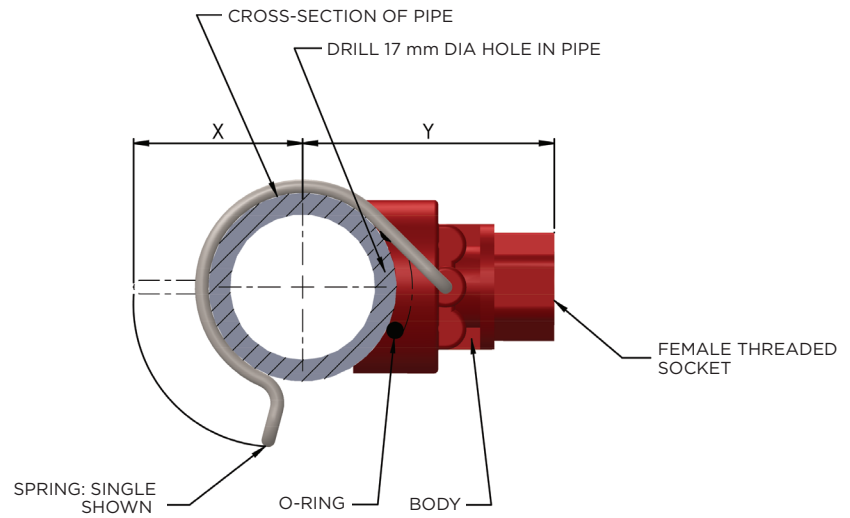

### MAJOR DIMENSIONS

Pipe (mm)	X	Y	Reg. Spigot 17 mm
25 mm	43	51	Blue
32 mm	48	56	Red
40 mm	51	58	Purple
50 mm	57	64	Green

Also available with Double Springs for pressures from 4 to 10 bar.

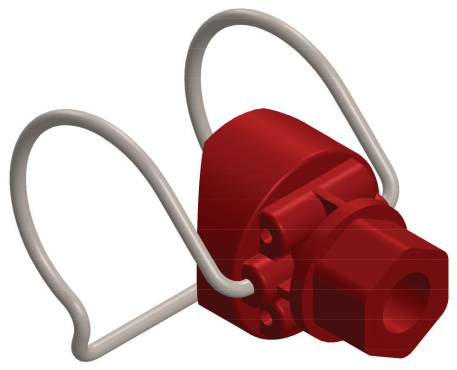



*Uni-Spray manufactures all its high-quality spray systems in Canada. These products are available globally and distributed in 65 countries.*

## Mark 2 Fixed Nozzle Adapter ORDERING INSTRUCTIONS

### How to order a Mark 2 Fixed Nozzle Adapter:

The complete Part Number tells us exactly what assembly you want.

For example, let's say that you want to order a Mark 2 Fixed Nozzle Adapter to fit onto a 32 mm (1 1/4") pipe, with Double Springs for high pressure, and a 1/4" NPT female threaded connection for use with your standard threaded nozzle tips:

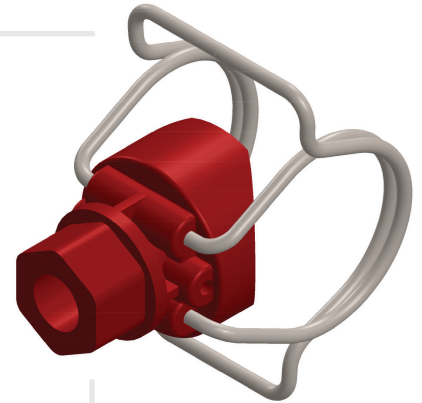

#### STEP 1

The Part Number begins with UNI, followed by the pipe:

UNI 100= 25 mm (1") pipe  
 UNI 125= 32 mm (1 1/4") pipe  
 UNI 150= 40 mm (1 1/2") pipe  
 UNI 200= 50 mm (2") pipe

So in our example, we would have so far

UNI 125

#### STEP 2

The Thread Sizes are shown as follows:

NPT	BSPT
18 N= 1/8" NPT	18 B= 1/8" BSPT
14 N= 1/4" NPT	14 B= 1/4" BSPT
38 N= 3/8" NPT	38 B= 3/8" BSPT
12 N= 1/2" NPT	12 B= 1/2" BSPT

In our example we now have

UNI 125 14 N

#### STEP 3

Add M2 D to denote the Style, where D stands for Double Spring. If you wanted a Single Spring, the Style would be M2 S.

So in our example, we end up with

UNI 125 14 N M2 D



## FEATURES

- Inexpensive
- Corrosion resistant
- Impervious to most chemicals
- Excellent heat resistance
- Injection-molded from custom-blended polypropylene
- Several thread sizes available
- Resists clogging
- Directional adjustment of nozzle anywhere within 45°
- Tips available in Full Cone, Hollow Cone, Flat Spray and Quick-Change configurations
- Tips available with Threaded Ball Connections in 1/8", 1/4", 3/8" and 1/2" BSPT threads
- Mark 3 nozzle bases allow the use of Adjustable Spray Nozzles in applications where threaded nozzles may currently be used
- Mark 3 bases also allow an Adjustable Nozzle where pipe diameters are larger than 50 mm (2") or smaller than 25 mm (1") by fitting with a threaded hole drilled in that pipe

## Mark 3 Adjustable Nozzle Assembly

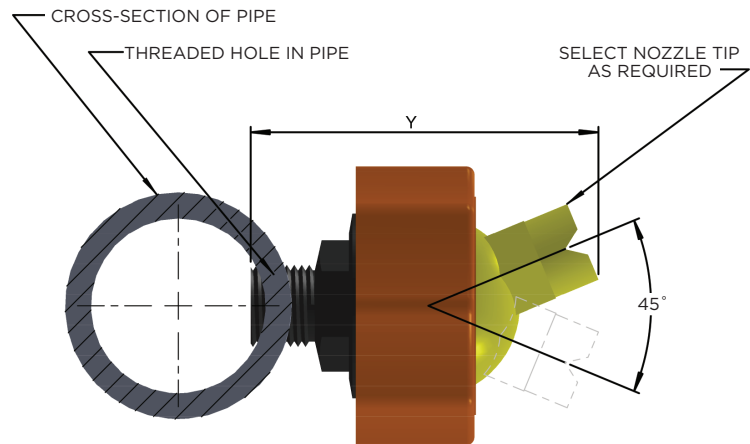

### MAJOR DIMENSIONS

	Y	Colour
1/4" Thread / BSPT	64 mm	White
3/8" Thread / BSPT	64 mm	Blue
1/2" Thread / BSPT	64 mm	Yellow

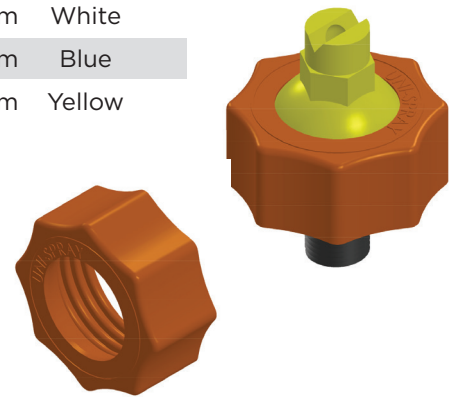

*Uni-Spray provides cutting-edge engineering design services as well as an entire range of products geared to the packaging industry.*

## Mark 3 Adjustable Nozzle Assembly ORDERING INSTRUCTIONS

### How to order a Mark 3 Adjustable Nozzle Assembly:

The complete Part Number tells us exactly what assembly you want.

For example, let say that you want to order a Mark 3 Adjustable Nozzle Assembly to fit a 1/4" BSPT thread with a 65° Flat Spray Nozzle Tip that will deliver 13 lpm at 2 bar:

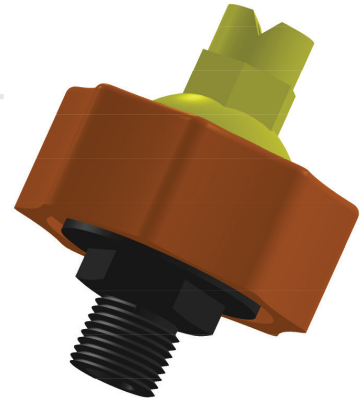

#### STEP 1

The Part Number begins with UNI, followed by the pipe size:

UNI 14 B= 6 mm (1/4") BSPT  
UNI 38 B= 10 mm (3/8") BSPT  
UNI 12 B= 13 mm (1/2") BSPT

So in our example, we would have so far

UNI 14 B

#### STEP 2

Select a Nozzle Tip from page 11 and add the Tip Number to the Part Number. In our example we now have

UNI 14 B 6540

Note that the UNI in front of the Tip Number on page 11 is dropped when the Tip Number is incorporated into the Assembly Part Number

#### STEP 3

Add M3 to denote the Style of base, which is our standard thread in Adjustable Nozzle bases. So in our example, we end up with

UNI 14 B 6540 M3

**Note:** Our Mark 3 nozzle bases have been designed to allow the use of Adjustable Spray Nozzles in applications where standard threaded nozzles may currently be used. They can also be utilized in applications where pipe sizes are smaller than 25 mm (1") or larger than 50 mm (2") in diameter, where clip-on nozzles might commonly be used.

## UNI-SPRAY NOZZLE TIPS: SPRAY NOZZLE COVERAGE

- ◀ **Flat Spray Nozzle:** High-impinging spray, excellent for cleaning, rinsing and sometimes phosphating.
- ◀ **Hollow Cone Nozzle:** Lower-impinging spray used where high surface coverage is required, such as in the zinc phosphate stage.
- ◀ **Full Cone Nozzle:** Used where full stationary coverage is required.
- ◀ **Flooding Nozzle:** Used where high flow rates are required, such as in the final rinse to eliminate solution carry-over.
- ◀ **Threaded Ball Connection:** Has NPT or BSPT female threads for attaching the nozzle of your choice.

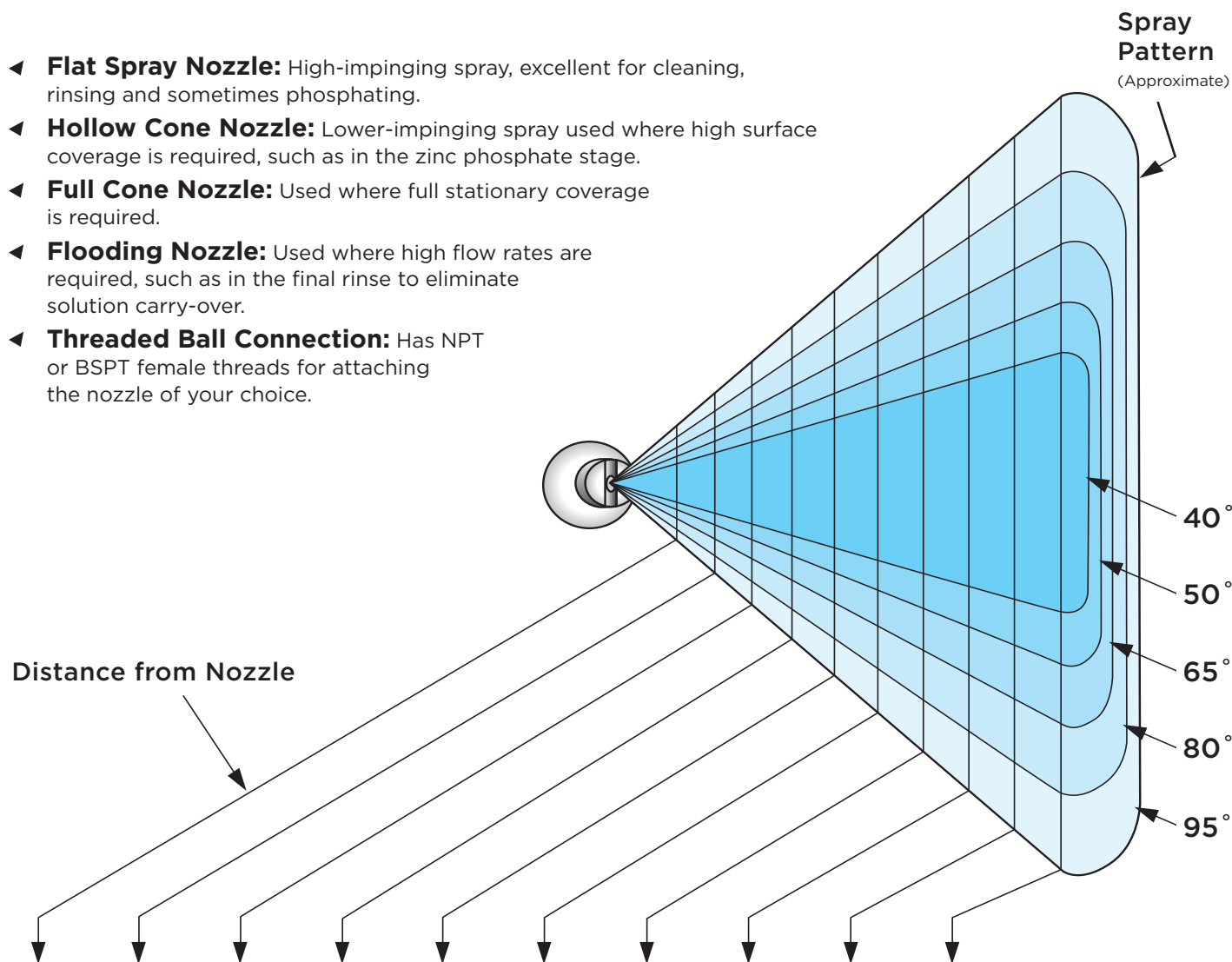

**HEIGHT OF INCLUDED ANGLE OF SPRAY COVERAGE (CM)**

10 cm	15 cm	20 cm	25 cm	30 cm	40 cm	50 cm	60 cm	75 cm	90 cm	@ Spray Angle
7.6	11.4	14.5	18.2	21.7	29.1	36.4	43.7	54.5	65.5	40°
9.4	14.2	18.8	23.2	28.0	37.3	46.7	56.0	70.0	84.1	50°
12.4	19.1	25.5	31.7	38.2	51.2	63.6	76.2	95.5	114.6	65°
17.0	25.4	33.5	42.0	50.5	67.2	84.2	100.7	126.0	151.1	80°
21.8	33.0	43.8	54.5	65.5	87.5	109.2	131.0	163.7	196.6	95°

## FLAT SPRAY NOZZLE TIP SELECTION DATA

ITEM NO.	NOZZLE TIP PART NUMBER	TIP COLOUR	SPRAY ANGLE	SPRAY PATTERN	CAPACITY LPM AT BAR					
					0.5	0.7	1	2	3	5
001	UNI 0080	Dk. Green	0°	Flat Spray	12.92	15.30	18.28	25.84	31.65	40.86
002	UNI 3040	Black	30°	Flat Spray	6.59	7.80	9.32	13.18	16.14	20.84
003	UNI 4050	Dk. Green	40°	Flat Spray	8.17	9.67	11.56	16.34	20.02	25.84
004	UNI 4020	Turquoise	40°	Flat Spray	3.16	3.74	4.47	6.32	7.75	10.00
005	UNI 50100	Grey	50°	Flat Spray	16.09	19.04	22.75	32.17	39.40	50.87
006	UNI 5070	Blue	50°	Flat Spray	11.34	13.42	16.04	22.68	27.78	35.86
007	UNI 5060	Orange	50°	Flat Spray	9.76	11.55	13.80	19.52	23.91	30.86
008	UNI 5050	Pink	50°	Flat Spray	8.17	9.67	11.56	16.34	20.02	25.84
009	UNI 5040	Mauve	50°	Flat Spray	6.59	7.80	9.32	13.18	16.14	20.84
010	UNI 5030	Blue	50°	Flat Spray	4.74	5.62	6.71	9.49	11.62	15.00
011	UNI 5020	Lt. Green	50°	Flat Spray	3.16	3.74	4.47	6.32	7.75	10.00
012	UNI 6560	Green	65°	Flat Spray	9.76	11.55	13.80	19.52	23.91	30.86
013	UNI 6550	Red	65°	Flat Spray	8.17	9.67	11.56	16.34	20.02	25.84
014	UNI 6540	Yellow	65°	Flat Spray	6.59	7.80	9.32	13.18	16.14	20.84
015	UNI 6530	Purple	65°	Flat Spray	4.74	5.62	6.71	9.49	11.62	15.00
016	UNI 6520	Grey	65°	Flat Spray	3.16	3.74	4.47	6.32	7.75	10.00
017	UNI 8070	Beige	80°	Flat Spray	11.34	13.42	16.04	22.68	27.78	35.86
018	UNI 8060	Beige	80°	Flat Spray	9.76	11.55	13.80	19.52	23.91	30.86
019	UNI 8050	Dk. Green	80°	Flat Spray	8.17	9.67	11.56	16.34	20.02	25.84
020	UNI 8040	Beige	80°	Flat Spray	6.59	7.80	9.32	13.18	16.14	20.84
021	UNI 8010	Black	80°	Flat Spray	1.58	1.87	2.24	3.16	3.87	5.00
022	UNI 8006	Lt. Green	80°	Flat Spray	0.98	1.15	1.38	1.95	2.39	3.08
023	UNI 9560	Dk. Green	95°	Flat Spray	9.76	11.55	13.80	19.52	23.91	30.86
024	UNI 12010	Grey	120°	Flat Spray	1.58	1.87	2.24	3.16	3.87	5.00
025	UNI 12070	Black	120°	Flat Spray	11.34	13.42	16.04	22.68	27.78	35.86
026	UNIPLUG	Grey	PLUG TO BLANK-OFF SPRAY							

For easy identification, all Flat Spray Nozzle Tips have the Tip Numbers molded into the ends of the tips. When ordering Nozzle Tips as spare parts, add TIP after the part Number: e.g., **UNI 6540TIP**

**CUSTOM NOZZLE DESIGNS ARE AVAILABLE UPON REQUEST**

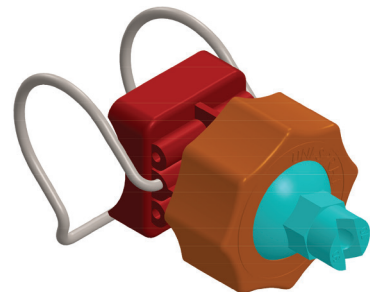
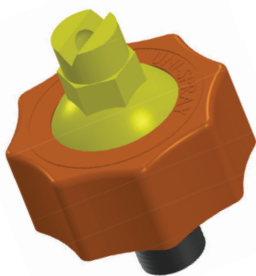

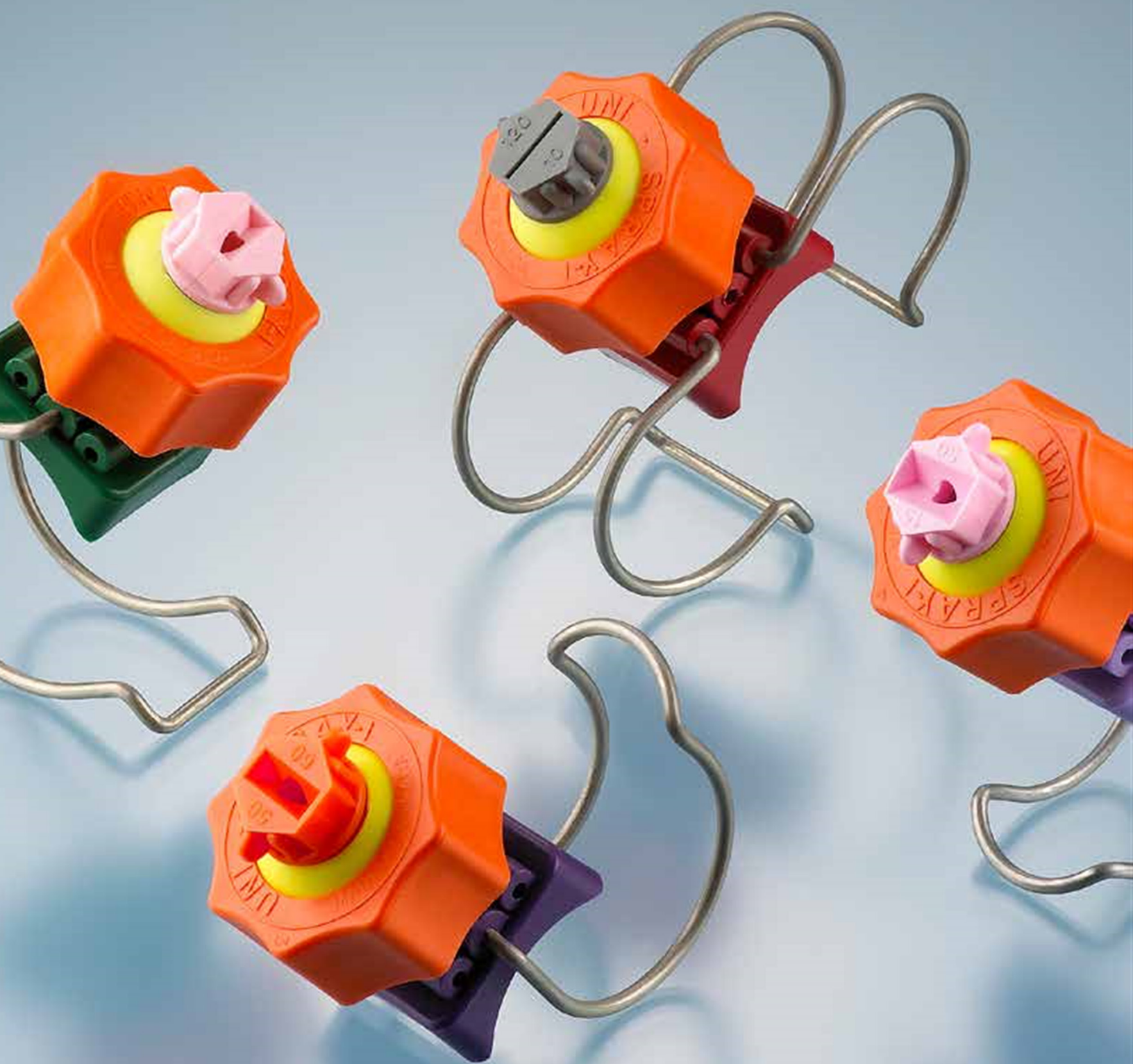

## UNI-SPRAY QUICK-CHANGE NOZZLE TIP

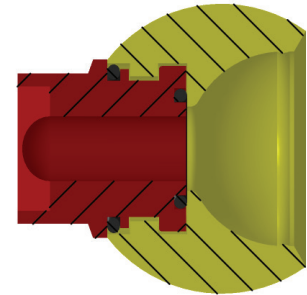
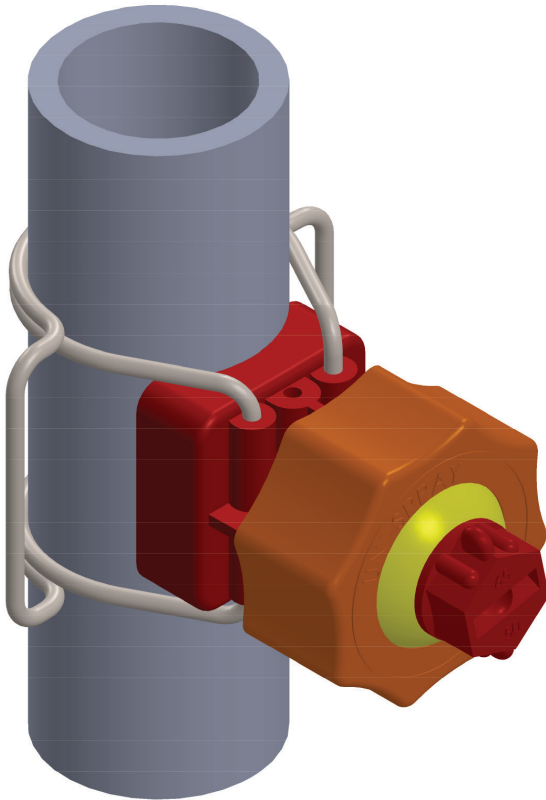

The “Quik-Change” Nozzle Tip is installed with a bayonet mount, and a simple 90° twist is all it takes to lock it into the ball. It is O-Ring sealed at the bottom and lip sealed at the top to prevent the mounting slots and tabs from becoming contaminated and difficult to disassemble.

The exterior dimensions and contours of the ball are identical to our standard Adjustable Nozzle Tips, so the full range of adjustment is still available. However, the tip length has been shortened from that of our standard tips, providing even greater clearance between the spray nozzle and your product.

The Uni-Spray Systems’ Quik-Change Tip has been developed to meet our customers’ demands! Manufactured to exacting standards from the highest-quality engineered thermoplastics, the Quik-Change Tip demonstrates our ongoing commitment to research and development, high-performance replacement parts and innovative new products for the pretreatment industry worldwide.

Quik-Change Tips will greatly reduce maintenance downtime by allowing replacement of all the tips in your system without having to painstakingly realign the adjustable tip angles and orientations on every nozzle. Quick-Change Tips are available in various Flat Spray Tip configurations. Custom spray angles and flow requirements are also available.

## QUICK-CHANGE NOZZLE TIP SELECTION DATA

ITEM NO.	NOZZLE TIP PART NUMBER	TIP COLOUR	SPRAY ANGLE	SPRAY PATTERN	CAPACITY (US) LPM AT BAR					
					0.5	0.7	1	2	3	5
027	UNI 0080QC	Dk. Green	0°	Flat Spray	12.92	15.30	18.28	25.84	31.65	40.86
028	UNI 1550QC	Pink	15°	Flat Spray	7.91	9.37	11.19	15.83	19.38	25.03
029	UNI 50100QC	Grey	50°	Flat Spray	16.09	19.04	22.75	32.17	39.40	50.87
030	UNI 5070QC	Blue	50°	Flat Spray	11.34	13.42	16.04	22.68	27.78	35.86
031	UNI 5060QC	Orange	50°	Flat Spray	9.76	11.55	13.80	19.52	23.91	30.86
032	UNI 5050QC	Pink	50°	Flat Spray	8.17	9.67	11.56	16.34	20.02	25.84
033	UNI 65100QC	Lt. Green	65°	Flat Spray	16.09	19.04	22.75	32.17	39.40	50.87
034	UNI 65700QC	Red	65°	Flat Spray	11.34	13.42	16.04	22.68	27.78	35.86
035	UNI 6560QC	Green	65°	Flat Spray	9.76	11.55	13.80	19.52	23.91	30.86
036	UNI 6550QC	Red	65°	Flat Spray	8.17	9.67	11.56	16.34	20.02	25.84
037	UNI 6540QC	Yellow	65°	Flat Spray	6.59	7.80	9.32	13.18	16.14	20.84
038	UNI 6530QC	Purple	65°	Flat Spray	4.74	5.62	6.71	9.49	11.62	15.00
039	UNI 8070QC	Beige	80°	Flat Spray	11.34	13.42	16.04	22.68	27.78	35.86
040	UNI 8050QC	Dk. Green	80°	Flat Spray	8.17	9.67	11.56	16.34	20.02	25.84
041	UNI 8040QC	Beige	80°	Flat Spray	6.59	7.80	9.32	13.18	16.14	20.84
042	UNI 8020QC	Yellow	80°	Flat Spray	3.16	3.74	4.47	6.32	7.75	10.00
043	UNI 8010QC	Black	80°	Flat Spray	1.58	1.87	2.24	3.16	3.87	5.00
044	UNI 8006QC	Lt. Green	80°	Flat Spray	0.98	1.15	1.38	1.95	2.39	3.08
045	UNI 9540QC	Black	95°	Flat Spray	6.59	7.80	9.32	13.18	16.14	20.84
046	UNI 9530QC	Grey	95°	Flat Spray	4.74	5.62	6.71	9.49	11.62	15.00
047	UNI 9520QC	Red	95°	Flat Spray	3.16	3.74	4.47	6.32	7.75	10.00
048	UNI 9503QC	Orange	95°	Flat Spray	47.37	56.07	67.00	94.73	116.04	149.80
049	UNI 12010QC	Grey	120°	Flat Spray	1.58	1.87	2.24	3.16	3.87	5.00
050	UNI 12070QC	Black	120°	Flat Spray	11.34	13.42	16.04	22.68	27.78	35.86
051	UNI 29HCQC	Dk. Green	50°	Hollow Cone	9.23	10.93	13.05	18.46	22.61	29.19
052	UNI 50HCQC	Black	65°	Hollow Cone	15.82	18.73	22.37	31.64	38.75	50.03
053	UNIPLUGQC	Grey	PLUG TO BLANK OFF SPRAY							

For easy identification, all Flat Spray Nozzle Tips have the Tip Numbers molded into the ends of the tips. When ordering Nozzle Tips as spare parts, add QCTIP after the Part Number: e.g., **UNI 6540QCTIP**

**CUSTOM NOZZLE DESIGNS ARE AVAILABLE UPON REQUEST**

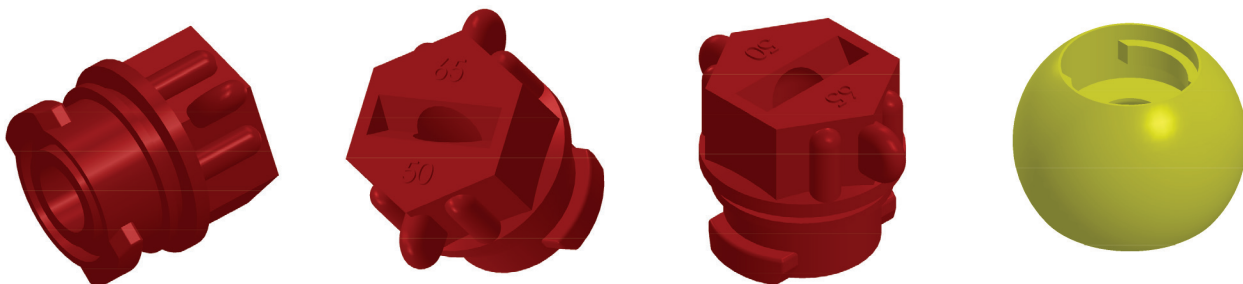



## HOLLOW CONE/FULL CONE NOZZLE TIP SELECTION DATA

ITEM NO.	NOZZLE TIP PART NUMBER	TIP COLOUR	SPRAY ANGLE	SPRAY PATTERN	CAPACITY (US) LPM AT BAR					
					0.5	0.7	1	2	3	5
054	UNI 29 HC	Dk. Green	50°	Hollow Cone	9.40	11.13	13.30	18.81	23.04	29.74
055	UNI 50 HC	Black	65°	Hollow Cone	15.82	18.73	22.37	31.64	38.75	50.03
056	UNI 08 HC	Blue	90°	Hollow Cone	2.38	2.81	3.36	4.75	5.82	7.51
057	UNI 20 HC	Orange	65°	Hollow Cone	6.33	7.49	8.95	12.65	15.49	20.00
058	UNI 25 HC	Red	65°	Hollow Cone	6.86	8.11	9.69	13.71	16.79	21.68
059	UNI 35 HC	Blue	65°	Hollow Cone	11.61	13.74	16.41	23.21	28.43	36.70
060	UNI 16 FC	Turquoise	40°	Full Cone	5.01	5.93	7.08	10.02	12.27	15.84
061	UNI 17 FC	Yellow	80°	Full Cone	5.27	6.24	7.46	10.55	12.92	16.68
062	UNI 52 FC	Pink	65°	Full Cone	16.35	19.35	23.12	32.70	40.05	51.70

**CUSTOM NOZZLE DESIGNS ARE AVAILABLE UPON REQUEST**

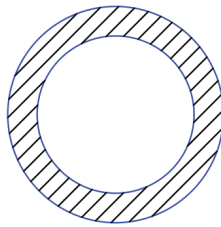
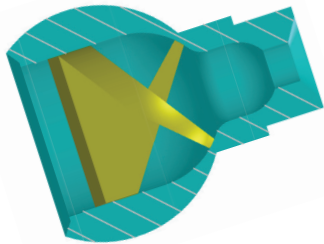

Hollow Cone Pattern

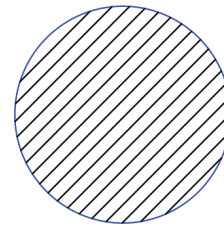

Full Cone Pattern

## THREADED BALL SELECTION DATA

064	UNI 1/8 BSPT	Beige	1/8" BSPT FEMALE THREADED CONNECTION
066	UNI 1/4 BSPT	Beige	1/4" BSPT FEMALE THREADED CONNECTION
068	UNI 3/8 BSPT	Beige	3/8" BSPT FEMALE THREADED CONNECTION
070	UNI 1/2 BSPT	Beige	1/2" BSPT FEMALE THREADED CONNECTION

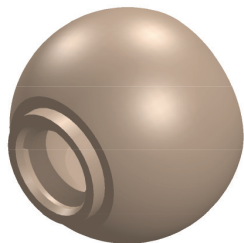

Uni-Spray also carries a large line of threaded nozzles for every application. Materials ranging from PVC to stainless steel are available in many thread sizes.

**PLEASE CALL TO DISCUSS A NOZZLE FOR YOUR SPECIFIC APPLICATION.**

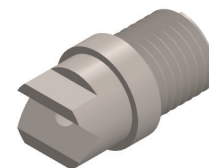

# SPRAY NOZZLE COMPONENTS

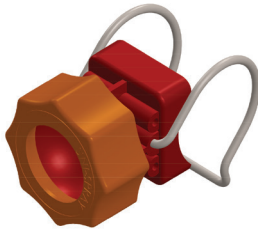

**MARK 1 ASSEMBLY (NO TIP) SINGLE CLAMP**  
UNI 100 BSOC  
UNI 125 BSOC  
UNI 150 BSOC  
UNI 200 BSOC

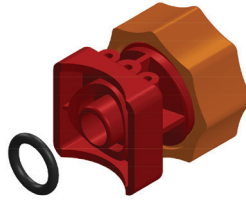

**MARK 1 BODY, CAP AND O-RING**  
UNI 100 BCO  
UNI 125 BCO  
UNI 150 BCO  
UNI 200 BCO

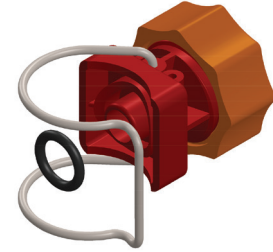

**MARK 1 BODY, SINGLE CLAMP AND O-RING**  
UNI 100 BCO  
UNI 125 BCO  
UNI 150 BCO  
UNI 200 BCO

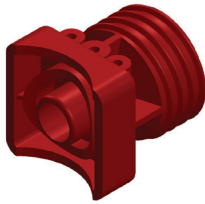

**MARK 1 BODY ONLY**  
UNI 100 B  
UNI 125 B  
UNI 150 B  
UNI 200 B

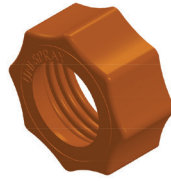

**MARK 1 CAP**  
UNI RC

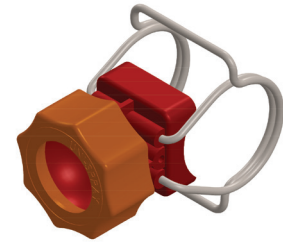

**MARK 1 ASSEMBLY (NO TIP) DOUBLE CLAMP**  
UNI 100 BSOC  
UNI 125 BSOC  
UNI 150 BSOC  
UNI 200 BSOC

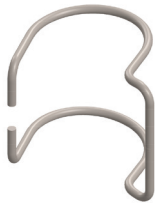

**MARK 1 OR MARK 2 SINGLE CLAMP**  
UNI 100 SS  
UNI 125 SS  
UNI 150 SS  
UNI 200 SS



**MARK 1 OR MARK 2 DOUBLE CLAMP SET**  
UNI 100 SS *plus* UNI 100 DW  
UNI 125 SS *plus* UNI 125 DW  
UNI 150 SS *plus* UNI 150 DW  
UNI 200 SS *plus* UNI 200 DW



**MARK 1 OR MARK 2 O-RING**  
UNI ODM EPDW  
UNI OVT VITON

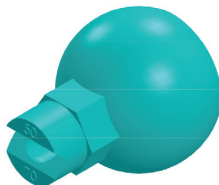

**NOZZLE TIP**  
SEE PAGES 11 and 14

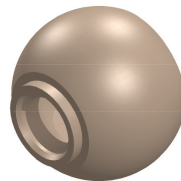

**THREADED BALL**  
SEE PAGE 14

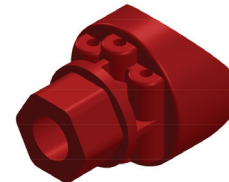

**MARK 2 ADAPTER BODY**  
UNI 100 M2 B  
UNI 125 M2 B  
UNI 150 M2 B  
UNI 200 M2 B



**MARK 3 ASSEMBLY BASE**  
SEE PAGES 8 and 9



**QUICK CHANGE TIP**  
SEE PAGES 12 and 13

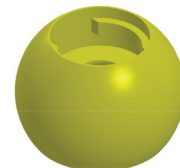

**QUICK CHANGE BALL**  
SEE PAGES 12 and 13

# THREADED NOZZLE TYPE

## SPIRAL

**TF**

**TFXP**

**TFXPW**

**TF29-180**

**ST**

**STXP**

**LEM**

**N**

**L**

## WHIRL: FULL CONE

**CW**

**CLUMP**

**MAXIPASS**

**NC**

**NCFL**

**NCJ\*/NCK**

**NCS**

**SC**

**TC**

**WL**

**WTZ**

## WHIRL: HOLLOW CONE

**TWIST & DRY**

**TDL**

**TH**

**THW**

**WT**

**WTX**

**FAN**

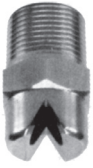

**NF**

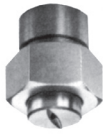

**NFD**



**NFS**



**FF**



**BJ**



**SPN**

**MISTING**



**P**



**PJ**



**MICROWHIRL**



**MWH**



**ULTIMIST**

**AIR ATOMIZING**



**SPIRAL AIR**

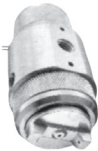

**SAM**



**XA**

**SPECIAL PURPOSE & ACCESSORIES**



**SJ**



**EZ**



**FINZ**

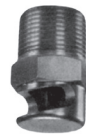

**IS**



**LP**



**PSR**



**RTW**



**SCRUBMATE**



**SS**



**TW**

## Nozzle Type

In general, Full Cone Nozzles have the largest droplets, followed by Flat Spray Nozzles and Hollow Cone Nozzles. For a better description of the characteristics of various types of spray nozzles, refer to pages 10 and 14.

## Flow Rate

If you select a nozzle with a greater flow rate at the same pressure, droplet size increases. For example, a UNI 6550 Flat Spray Nozzle at 2.8 bar and a flow rate of 7.6 lpm will have a larger droplet size than a UNI 6540 Flat Spray Nozzle at 2.8 bar, which has a flow rate of only 15.1 lpm.

## Pressure

As the pressure on any given nozzle increases, droplet size will decrease. For example, the same UNI 6550 Flat Spray Nozzle has a larger droplet size at 2.8 bar pressure than it does at 3.5 bar.

Of the factors affecting flow rate, the most influential is pressure. Theoretically, flow rate varies in correlation with the square root of the pressure, neglecting all other factors. To compute pressures and flow rates other than those on pages 11, 13, and 14 the following formulas may be used:

$$Q_2 = Q_1 \sqrt{\frac{P_2}{P_1}} \quad P_2 = P_1 \left( \frac{Q_2}{Q_1} \right)^2$$

Q1 and P1 are the known flow rate and pressure.  
Q2 is the resulting flow rate from the new pressure P2.  
P2 is the resulting pressure from the new flow rate Q2.

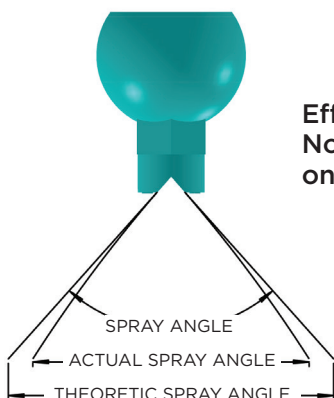

**Effect of Nozzle Wear on Spray Angle**

## Temperature

Changing temperature can alter a liquid's viscosity, surface tension, and specific gravity, and this in turn changes nozzle performance.

Viscosity generally changes significantly with temperature. As the temperature drops, viscosity increases, which increases the energy required to form a spray, and also increases droplet size. The performance data supplied on pages 11, 13, and 14 is based on spraying water at room temperature. The lower the specific gravity of a fluid, the higher the flow rate through the nozzle at the same pressure, as shown in the following equation:

$$(Q \text{ water}) \times \frac{1}{\sqrt{SG \text{ fluid}}} = (Q \text{ fluid})$$

For example, the flow rate of a fluid with a specific gravity of 1.3 would be about 87% of the flow rate of water.

$$(15.1 \text{ lpm water}) \times \frac{1}{\sqrt{1.3}} = (13.2 \text{ lpm fluid})$$

Increasing surface tension increases the effort required to atomize the spray, which increases the droplet size and reduces the spray angle.

## Spray Angle

Increasing the spray angle will reduce the droplet size. For example, a UNI 6550 nozzle with a 65° spray angle and 19 lpm at 2.8 bar will have a finer droplet size than a UNI 5050 nozzle with a 50° spray angle at the same pressure and flow.

At any given pressure and flow, the impact force or impingement of a spray will be increased by a narrower spray angle and, depending on your application, should be taken into account.

Nozzle wear can also affect the spray angle. As nozzle wear increases, the orifice gets bigger, and flow rate increases, which in turn can result in a loss of system pressure. This loss of spray pressure can often be recognized by a narrowing of the spray pattern or by a general loss of uniformity in the spray pattern.



## QUIK-DISCONNECT SELECTION GUIDE

- ◀ Cam-Operated Couplings provide easy access for the cleaning and installation of spray risers.
- ◀ They adapt to standard steel or non-corrosive risers and headers in sizes from 25 mm to 100 mm and are available in Ny-Glass, Poly-Glass or PVDF.

### To make up a Quik-Disconnect junction

- ◀ You must have one female connector assembly (Part B, C, or D) which incorporates the cam-lock arms, and one male connector (Part A, E, or F) which is shaped to precisely fit into the socket on the mating part and be held securely against the sealing gasket by the unique cam-lock mechanism.
- ◀ The female connectors connect to your pipe system by an external NPT thread (Part B), an internal NPT thread (Part D) or a hose barb (Part C). The male connectors likewise connect to your pipes by an internal NPT thread (Part A), an external thread (Part F), or a hose barb (Part E). And, to cap off any section which terminates with a female connector, use the available plug (Part DP). The Quik-Disconnects can be combined with our Clamp-On Nozzles and Nozzle Adapters, Quik-Lock Formed Risers and Headers, Quik-Release Riser Supports, and Ball Valves to make up complete spray header systems that provide unparalleled ease of installation and use.
- ◀ To increase the value of your investment in Uni-Spray Quik-Disconnect couplings, we provide a complete line of replacement parts for the assemblies. It is no longer necessary to discard an entire assembly just because one part is broken. Refer to the following pages for complete information and specifications for the full Quik-Disconnect line.



### Available Sizes

All Quik-Disconnect plastic components are colour-coded for convenient identification, and are available to fit the following pipe sizes:

(mm)	Thread Type	Poly-Glass	Ny-Glass	PVDF
25 mm	BSPT	Black	Yellow	White
32 mm	BSPT	Red	Yellow	White
40 mm	BSPT	Purple	Yellow	White
50 mm	BSPT	Black	Yellow	White
75 mm	BSPT	Black	Yellow	White
100 mm	BSPT	Black	Yellow	White

## QUICK-DISCONNECT COUPLINGS AND ADAPTERS

**Note:** 32 mm (1 1/4") through 40 mm (1 1/2") Parts B, C, D and DC assemblies will be shipped with Ny-Glass Arms unless Stainless Steel Arms are requested. Assemblies are supplied complete with retaining clips.

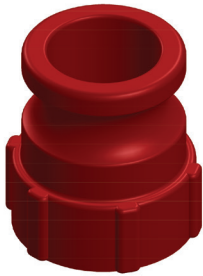

**PART A**  
ADAPTER x FT



**PART B**  
COUPLER x MT



**PART C**  
COUPLER x HOSE BARB



**PART D**  
COUPLER x FT



**PART E**  
ADAPTER x HOSE BARB

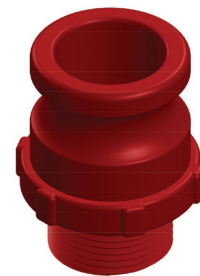

**PART F**  
ADAPTER x MT



**PART DP**  
PLUG



**PART DC**  
CAP

*Uni-Spray has been developing innovative products for industry since 1987. This continues to be a focus for the company's future. Please contact us with any new concepts.*



## Quik-Disconnect ORDERING INSTRUCTIONS

### How To Order A Quik-Disconnect Coupler or Adapter:

The complete Part Number tells us exactly what assembly you want.

For example, let's say that you want to order a cam-operated Part D: Coupler x FT (Female Thread) molded in Poly-Glass, to fit on a 75 mm (3") pipe:

#### STEP 1

The Part Number begins with UNI, followed by the pipe size:

- UNI 100= 25 mm (1") pipe
- UNI 125= 32 mm (1 1/4") pipe
- UNI 150= 40 mm (1 1/2") pipe
- UNI 200= 50 mm (2") pipe
- UNI 300= 75 mm (3") pipe
- UNI 400= 100 mm (4") pipe

So in our example, we would have so far

UNI 300

#### STEP 2

Identify the Style of component as shown on page 20, using our Part Code, which in this example is Part D, and we have

UNI 300 D

#### STEP 3

Finish the Part Number with the Material Code, as follows:

- NG = Ny-Glass
- PG = Poly-Glass
- K = PVDF

So in our example, we end up with

UNI 300 DPG



## QUIK-DISCONNECT DIMENSIONS

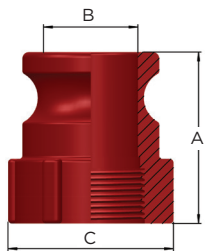

### PART A: ADAPTER x FT (mm)

SIZE CODE	100	125	150	200	300	400
Size of Thread	1"	1 1/4"	1 1/2"	2"	3"	4"
A Overall Length	47.6	69.9	69.9	74.6	74.6	95.3
B Minimum I.D.	20.6	36.5	36.5	42.9	71.4	95.3
C Maximum O.D.	44.5	63.5	63.5	77.8	122.2	133.4

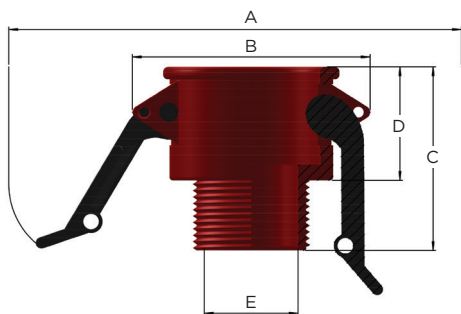

### PART B: COUPLER x MT (mm)

SIZE CODE	100	125	150	200	300	400
Size of Thread	1"	1 1/4"	1 1/2"	2"	3"	4"
A O.D. with Arms Out	120.7	208.0	208.0	220.7	252.4	281.0
B Maximum O.D.	63.5	95.3	95.3	103.2	127.0	166.7
C Overall Length	63.5	69.9	69.9	82.6	84.1	100.0
D Exposed Length	39.7	47.6	47.6	54.0	66.7	65.1
E Minimum I.D.	22.2	49.2	38.1	47.6	73.0	98.4

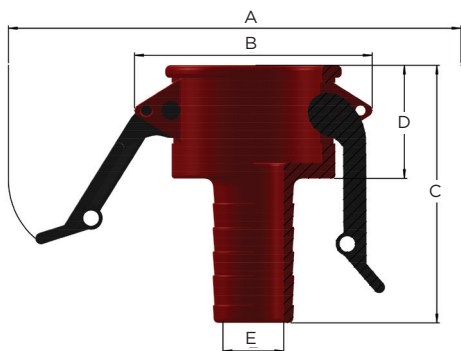

### PART C: COUPLER x HOSE BARB (mm)

SIZE CODE	100	125	150	200	300	400
Size of Hose Barb	25	32	40	50	75	100
A O.D. with Arms Out	120.7	208.0	208.0	220.7	252.4	281.0
B Maximum O.D.	63.5	95.3	95.3	103.2	127.0	166.7
C Overall Length	96.8	108.0	108.0	125.4	160.3	158.8
D Exposed Length	39.7	47.6	47.6	54.0	60.3	65.1
E Minimum I.D.	20.6	23.8	30.2	41.3	65.1	88.9

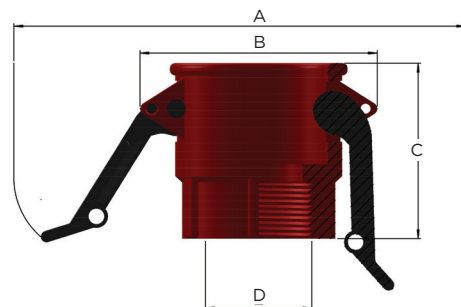

### PART D: COUPLER x FT (mm)

SIZE CODE	100	125	150	200	300	400
Size of Thread	1"	1 1/4"	1 1/2"	2"	3"	4"
A O.D. with Arms Out	120.7	208.0	208.0	220.7	252.4	281.0
B Maximum O.D.	63.5	95.3	95.3	103.2	127.0	166.7
C Overall Length	61.9	69.9	69.9	82.6	82.6	101.6
D Minimum I.D.	25.4	38.1	41.3	42.9	73.0	98.4

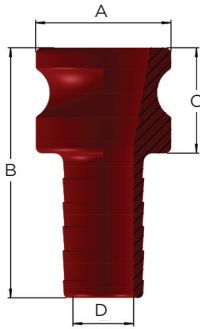
**PART E: ADAPTER x HOSE BARB (mm)**

SIZE CODE	100	125	150	200	300	400
Size of Hose Barb	25	32	40	50	75	100
A Maximum O.D.	36.5	53	53	63	91	120
B Overall Length	90.5	123	123	130	174	185
C Exposed Length	33.3	53	53	48	53	76
D Minimum I.D.	20.6	30	30	41	61	130

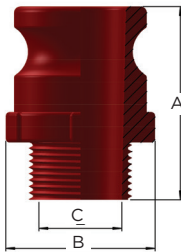
**PART F: ADAPTER x MT (mm)**

SIZE CODE	100	125	150	200	300	400
Size of Thread	1"	1 1/4"	1 1/2"	2"	3"	4"
A Overall Length	68.3	79.4	79.4	89.0	100.0	115.9
B Maximum O.D.	44.5	63.5	63.5	77.8	122.2	133.4
C Minimum I.D.	22.2	33.3	36.5	47.6	69.9	98.4

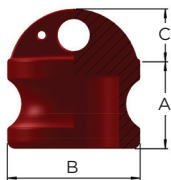
**PART DP: PLUG (mm)**



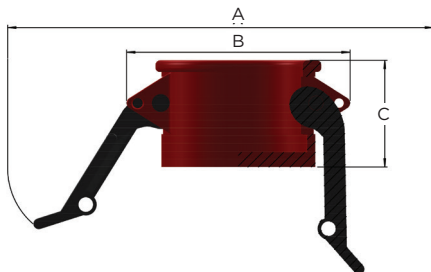





SIZE CODE	100	125	150	200	300	400
Nominal Pipe Size	1"	1 1/4"	1 1/2"	2"	3"	4"
A Overall Length	34.9	36.5	36.5	49.2	52.4	55.6
B Maximum O.D.	36.5	54.0	54.0	63.5	92.1	119.1
C Lug Extension	9.5	11.1	11.1	9.5	12.7	12.7

**PART DC: CAP (mm)**

SIZE CODE	100	125	150	200	300	400
Nominal Pipe Size	1"	1 1/4"	1 1/2"	2"	3"	4"
A O.D. with Arms Out	120.7	208.0	208.0	220.7	252.4	281.0
B Maximum O.D.	63.5	95.3	95.3	103.2	127.0	166.7
C Overall Length	41.3	49.2	49.2	55.6	60.3	63.5

# QUIK-DISCONNECT REPLACEMENT PARTS

TO ORDER SPARE PARTS FOR YOUR ASSEMBLIES, USE THE PARTS GUIDE BELOW

COMPONENT	25 mm	32 mm	40 mm	50 mm	75 mm	100 mm
<b>PART B BODY: NY-GLASS OR PLOY-GLASS</b>						
	UNI 100 DNG-B	UNI 125 DNG-B	UNI 150 DNG-B	UNI 200 DNG-B	UNI 300 DNG-B	UNI 400 DNG-B
	UNI 100 DPG-B	UNI 125 DPG-B	UNI 150 DPG-B	UNI 200 DPG-B	UNI 300 DPG-B	UNI 400 DPG-B
	UNI 100 DK-B	UNI 125 DK-B	UNI 150 DK-B	UNI 200 DK-B	(N/A)	(N/A)
<b>PART C BODY: NY-GLASS OR POLY-GLASS</b>						
	UNI 100 CNG-B	UNI 125 CNG-B	UNI 150 CNG-B	UNI 200 CNG-B	UNI 300 CNG-B	UNI 400 CNG-B
	UNI 100 CPG-B	UNI 125 CPG-B	UNI 150 CPG-B	UNI 200 CPG-B	UNI 300 CPG-B	UNI 400 CPG-B
	UNI 100 CK-B	UNI 125 CK-B	UNI 150 CK-B	UNI 200 CK-B	(N/A)	(N/A)
<b>PART D BODY: NY-GLASS OR POLY-GLASS</b>						
	UNI 100 BNG-B	UNI 125 BNG-B	UNI 150 BNG-B	UNI 200 BNG-B	UNI 300 BNG-B	UNI 400 BNG-B
	UNI 100 BPG-B	UNI 125 BPG-B	UNI 150 BPG-B	UNI 200 BPG-B	UNI 300 BPG-B	UNI 400 BPG-B
	UNI 100 BK-B	UNI 125 BK-B	UNI 150 BK-B	UNI 200 BK-B	(N/A)	(N/A)
<b>PART DC BODY: NY-GLASS OR POLY-GLASS</b>						
	UNI 100 DCNG-B	UNI 125 DCNG-B	UNI 150 DCNG-B	UNI 200 DCNG-B	UNI 300 DCNG-B	UNI 400 DCNG-B
	UNI 100 DCPG-B	UNI 125 DCPG-B	UNI 150 DCPG-B	UNI 200 DCPG-B	UNI 300 DCPG-B	UNI 400 DCPG-B
	UNI 100 DCK-B	UNI 125 DCK-B	UNI 150 DCK-B	UNI 200 DCK-B	(N/A)	(N/A)
<b>GASKET, EPDM</b>						
	UNI G 1	UNI G 2	UNI G 3	UNI G 4	UNI G 5	
<b>CAM-LOCK ARM, NY-GLASS</b>						
	(N/A)	UNI AP 1	UNI AP 2	(N/A)		
<b>CAM-LOCK ARM 302 SS</b>						
	UNI AS 1	UNI AS 2	UNI AS 3	UNI AS 4		
<b>SPRING CLIP, 302 SS</b>						
	UNI C 1	UNI C 2	UNI C 3	UNI R 1 (RING, 302 SS)		
<b>PIN, 302 SS</b>						
	UNI P 1	UNI P 2	UNI P 3	UNI P 4		

TO ORDER COMPLETE ASSEMBLIES, USE THE ORDERING INSTRUCTIONS ON PAGE 21

## QUIK-DISCONNECT PIPE-END SEPARATION DISTANCES

Pipe-End Separation is the distance between the pipe ends being connected by means of the QUIK-DISCONNECT couplings.

The separation distance is given both as the distance when the couplers are engaged, and as the minimum distance required for disconnecting, assuming complete pipe thread engagement.

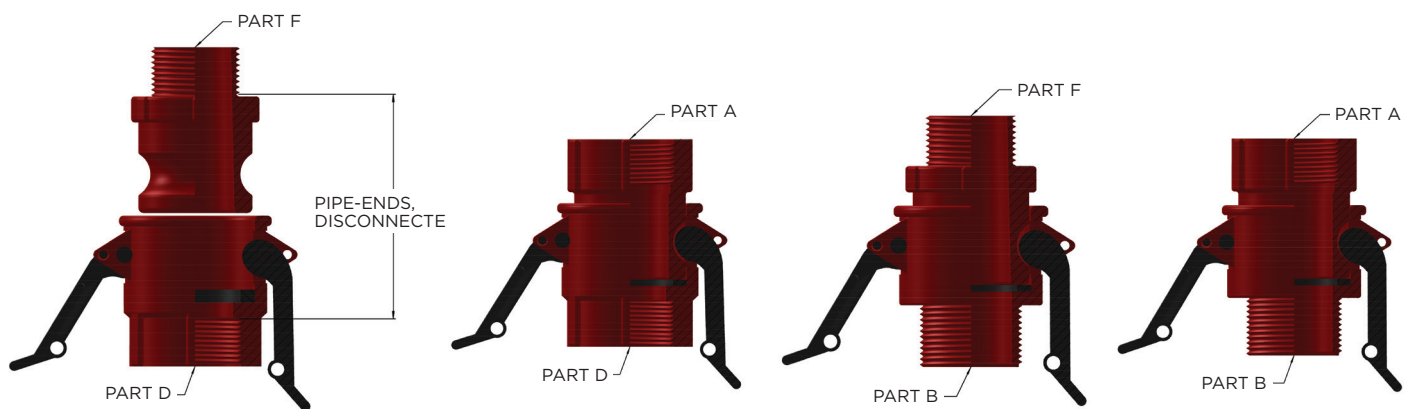

PIPE SIZE (mm)		D to F	D to A	B to F	B to A
25 mm (1")	CONNECTED	58.93	37.08	127.00	107.95
	DISCONNECTED	88.90	67.06	158.75	139.70
32 mm (1 1/4")	CONNECTED	68.07	56.90	117.48	107.95
	DISCONNECTED	103.12	92.96	149.23	142.88
40 mm (1 1/2")	CONNECTED	61.98	50.04	117.48	107.95
	DISCONNECTED	98.04	86.11	149.23	142.88
50 mm (2")	CONNECTED	69.09	57.91	142.88	127.00
	DISCONNECTED	113.03	102.11	184.15	171.45
75 mm (3")	CONNECTED	136.53	149.23	127.00	146.05
	DISCONNECTED	177.80	184.15	165.10	184.15
100 mm (4")	CONNECTED	180.98	180.98	180.98	190.50
	DISCONNECTED	225.43	225.43	225.43	234.95

TO ORDER COMPLETE ASSEMBLIES, USE THE ORDERING INSTRUCTIONS ON PAGE 21.

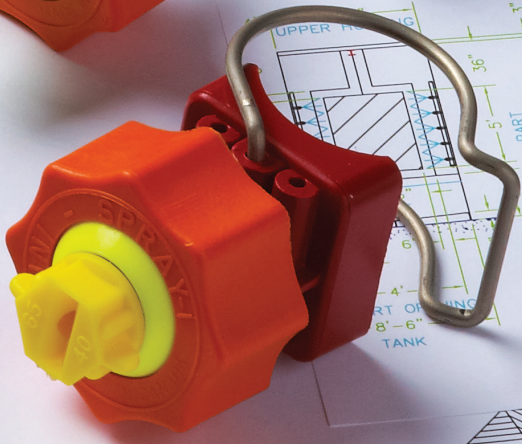
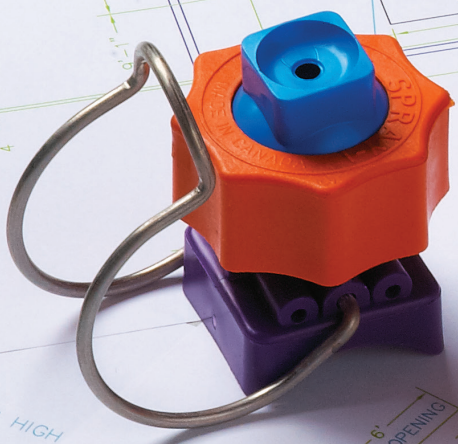
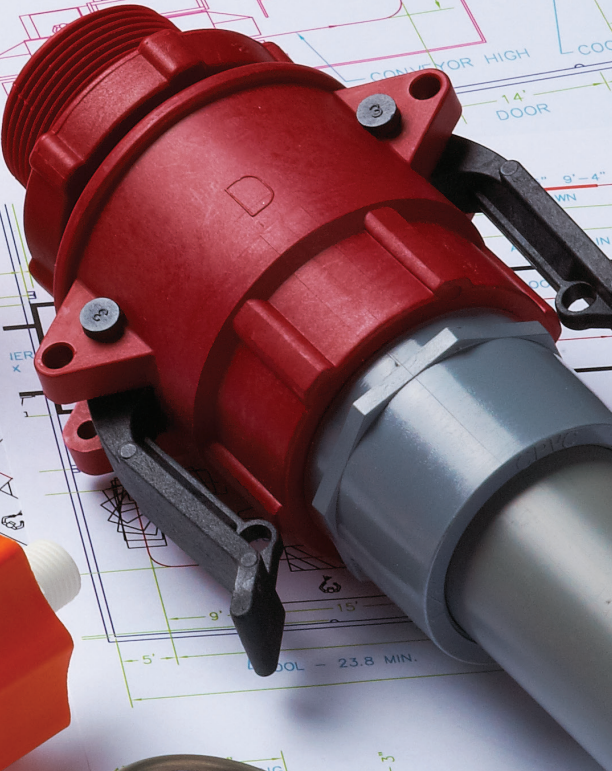
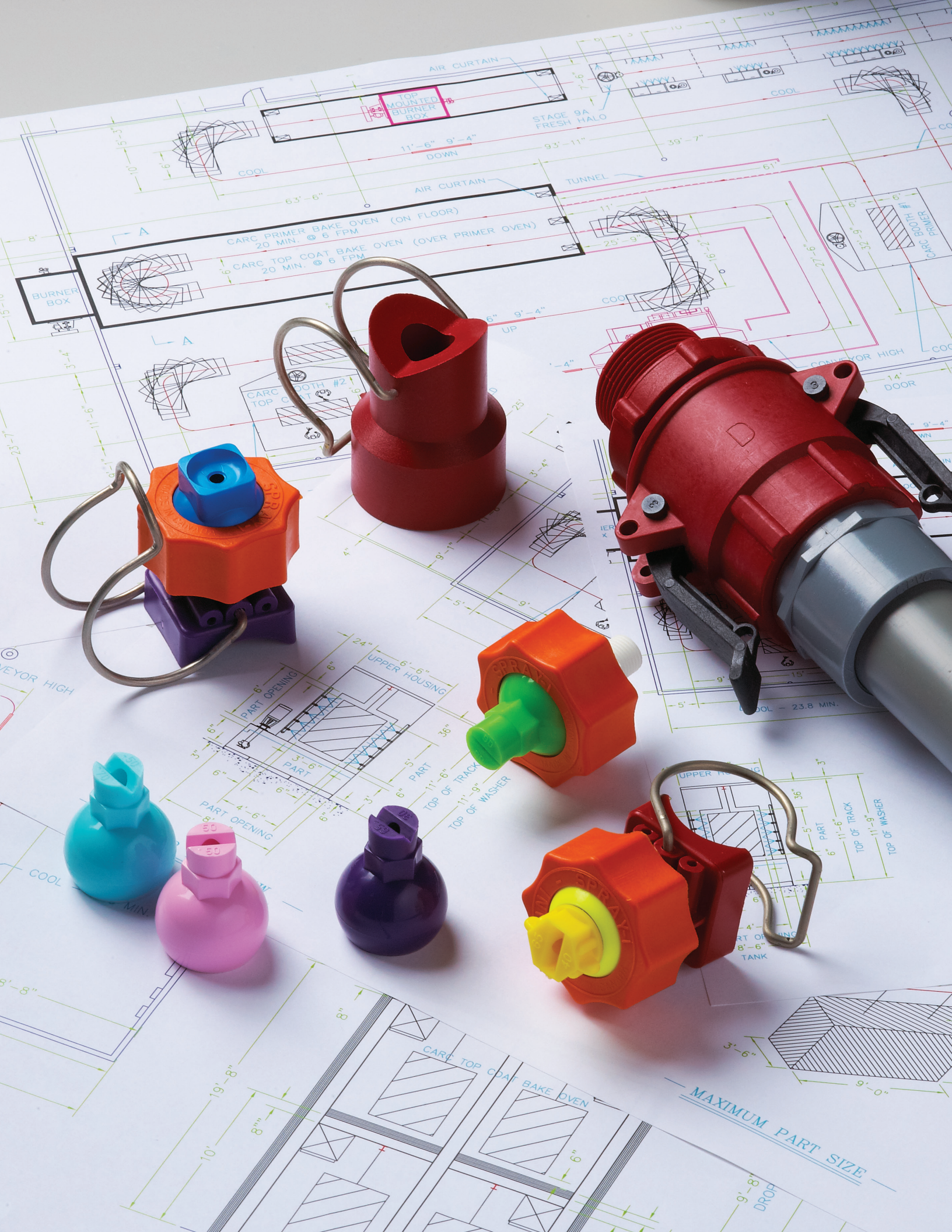



## THE UNI-SPRAY PIPE SADDLE SELECTION GUIDE

- ◀ High-quality injection-moulded pipe fitting which can be installed on an existing pipe in minutes.
- ◀ Made of polypropylene and highly resistant to a wide range of caustic and acid-based chemicals.
- ◀ Will operate effectively at pressures up to 10.3 bar in temperatures from 0° to 130 °C
- ◀ The Uni-Spray Pipe Saddle is well suited for use on I.P.S. outer dimension PVC, CPVC, stainless steel and black iron pipe.
- ◀ The Saddle will fit Schedule 40, Schedule 80, and SDR 13.5 through 64 pipe. Moreover, it also fits a variety of polyethylene and polybutylene pipe applications. These Saddles are available in 25 mm (1") through 150 mm (6") mainline pipe sizes, with a wide assortment of take-off sizes.
- ◀ Pipe Saddles eliminate the high cost of back welding female couplers to the thermoplastic, steel, or iron pipes, and are completely compatible with our Uni-Spray Quik-Disconnect couplers.

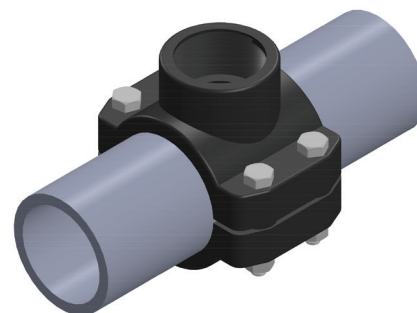
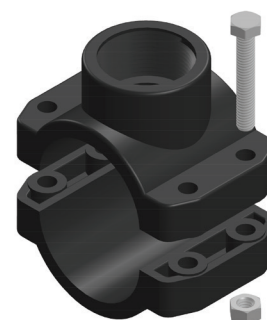

## Available Sizes

Refer to the chart below. Available combinations are indicated with an X.

		HEADER PIPE SIZE							
		1"	1 1/4"	1 1/2"	2"	2 1/2"	3"	4"	6"
TAKE-OFF SIZE	1/2" NPT	X	X	X					
	3/4" NPT	X	X	X	X				
	1" NPT		X	X	X	X	X	X	X
	1 1/4" NPT				X	X	X	X	X
	1 1/2" NPT				X	X	X	X	X
	2" NPT					X	X	X	X

## PIPE SADDLE INSTALLATION INSTRUCTIONS

### Product Advantages:

- ◀ The use of Pipe Saddles eliminates the higher cost of back welding female couplers to thermoplastic pipe and simplifies on-site installation and repairs.
- ◀ Raw material is polypropylene and resistant to a wide range of caustic and acid-based chemicals. Operating temperature range is approximately 0° to 130°C.
- ◀ Working pressure: will operate effectively at pressures up to 10.3 bar.
- ◀ Compression seal o-ring ensures sealing.

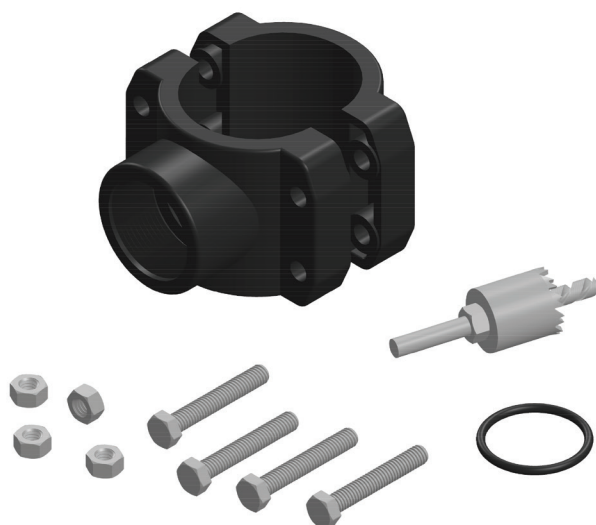

### To Assemble

1. Place the o-ring into saddle.
2. Position the saddle on the pipe.
3. Install the lower half and fasteners and partially tighten the bolts.
4. Check the saddle position and level, adjust if necessary, and then tighten the bolts evenly.
5. Drill a hole in the pipe through the saddle take-off.
6. Install the connecting pipe or Quik-Disconnect® fitting.

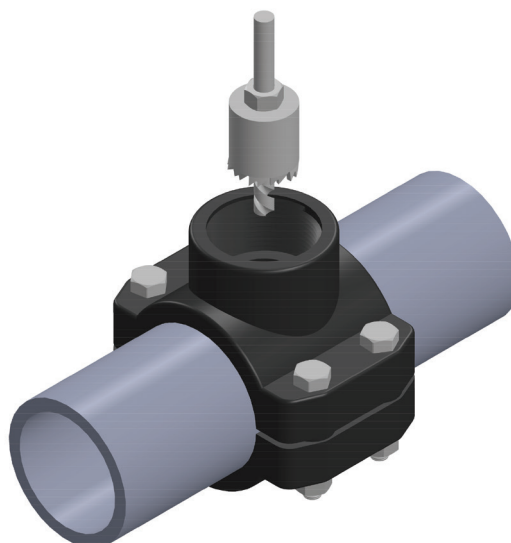
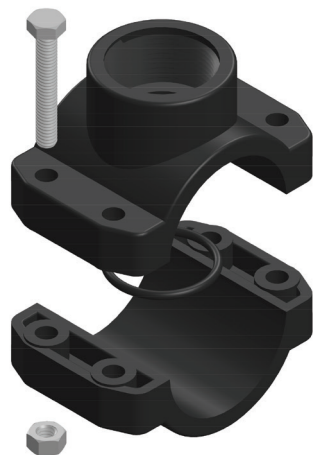

## PIPE SADDLE DIMENSIONS

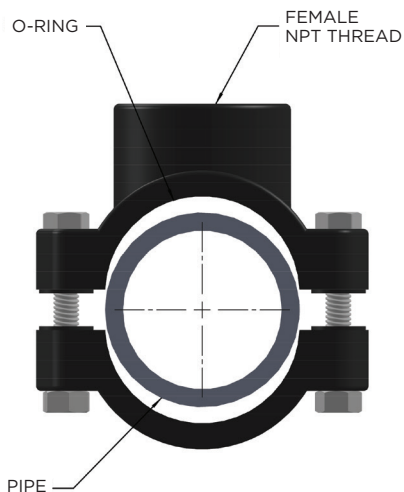
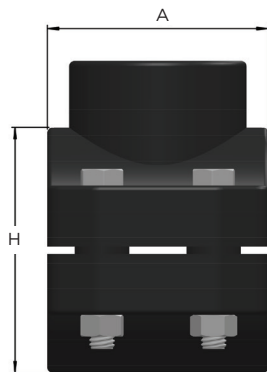
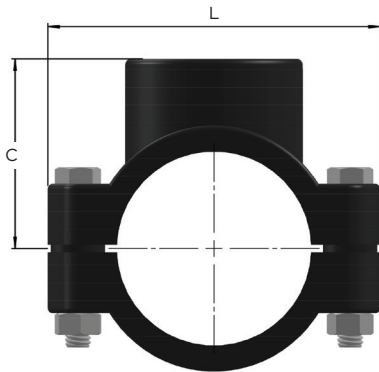

PART NO.	PIPE SIZE	TAKE-OFF	L	H	C	A
100SAD050	25 mm (1")	1/2"	79.1	42.0	40.0	49.0
100SAD075	25 mm (1")	3/4"	79.1	42.0	40.0	49.0
125SAD050	32 mm (1 1/4")	1/2"	86.0	52.1	45.0	62.0
125SAD075	32 mm (1 1/4")	3/4"	86.0	52.1	45.0	62.0
125SAD100	32 mm (1 1/4")	1"	86.0	52.1	45.0	62.0
150SAD050	40 mm (1 1/2")	1/2"	86.0	62.0	50.0	62.0
150SAD075	40 mm (1 1/2")	3/4"	86.0	62.0	50.0	62.0
150SAD100	40 mm (1 1/2")	1"	86.0	62.0	50.0	62.0
200SAD100	50 mm (2")	1"	101.1	77.1	58.1	62.0
200SAD125	50 mm (2")	1 1/4"	101.1	75.0	58.1	62.0
200SAD150	50 mm (2")	1 1/2"	101.1	75.0	58.1	62.0
250SAD100	63 mm (2 1/2")	1"	116.0	89.0	66.1	77.1
250SAD125	63 mm (2 1/2")	1 1/4"	116.0	89.0	66.1	77.1
250SAD150	63 mm (2 1/2")	1 1/2"	116.0	89.0	66.1	77.1
300SAD100	75 mm (3")	1"	132.0	106.1	77.1	87.0
300SAD125	75 mm (3")	1 1/4"	132.0	106.1	77.1	87.0
300SAD150	75 mm (3")	1 1/2"	132.0	106.1	77.1	87.0
300SAD200	75 mm (3")	2"	132.0	106.1	77.1	87.0
400SAD100	100 mm (4")	1"	172.0	140.0	94.0	101.0
400SAD125	100 mm (4")	1 1/4"	172.0	140.0	94.0	101.0
400SAD150	100 mm (4")	1 1/2"	172.0	140.0	94.0	101.0
400SAD200	100 mm (4")	2"	172.0	140.0	94.0	101.0
600SAD100	150 mm (6")	1"	236.9	191.8	133.6	168.0
600SAD125	150 mm (6")	1 1/4"	236.9	191.8	133.6	168.0
600SAD150	150 mm (6")	1 1/2"	236.9	191.8	133.6	168.0
600SAD200	150 mm (6")	2"	236.9	191.8	133.6	168.0



## Quik-Release Riser Support ORDERING INSTRUCTIONS

Quik-Release Riser Support dimensions are shown for 25 mm (1"), 32 mm (1 1/4"), 40 mm (1 1/2") and 50 mm (2") pipe risers.

Note: For these sizes, the Riser Support Bodies are identical in size, but the Spring sizes vary. The Body colour denotes the Spring size.

25 mm (1") = BLUE

32 mm (1 1/4") = RED

40 mm (1 1/2") = PURPLE

50 mm (2") = GREEN

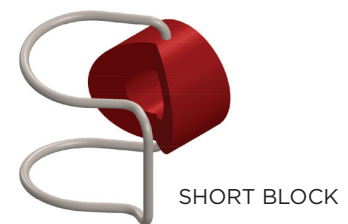
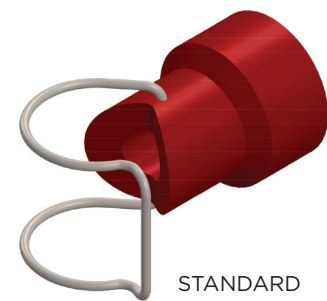
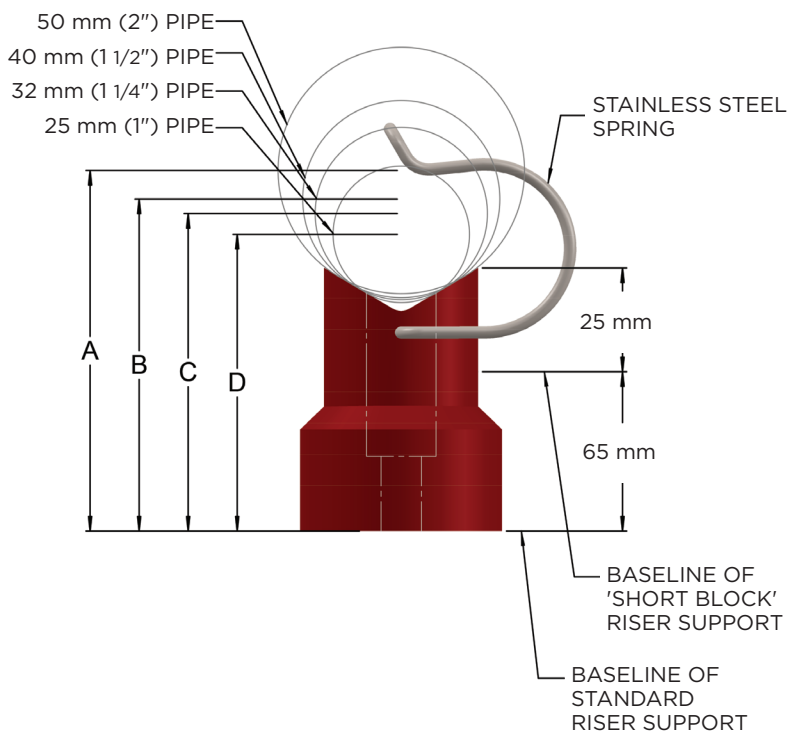

PIPE C/L TO WALL	A (50 mm Pipe)	B (40 mm Pipe)	C (32 mm Pipe)	D (25 mm Pipe)
RISER SUPPORT: STANDARD	88.9	82.6	79.4	74.9
PART NUMBER	QR200	QR150	QR125	QR100
RISER SUPPORT: SHORT BLOCK	50.8	44.5	41.3	36.8
PART NUMBER	QR200MINI	QR150MINI	QR125MINI	QR100MINI



## TME: TANK MIXING EDUCTORS

- Tank Mixing Eductors (TME's) enable small pumps to circulate large tanks. The suction produced by the venturi action of the eductor greatly amplifies the mixing ability of the pump. Solids in the tank are kept from settling by the velocity of the discharge plume. The eductors are placed on the tank to maintain critical velocity of the solid particles. Keeping the eductor at a slight downward angle can help maintain critical velocity on the tank floor.
- TMEs can be used in conjunction with Uni-Spray Saddles or Clip-On Nozzles for easy installation.
- Eductors are moulded of Glass-Reinforced Polypropylene, with a temperature range up to 130°C. They are also available in brass, stainless steel or Kynar.

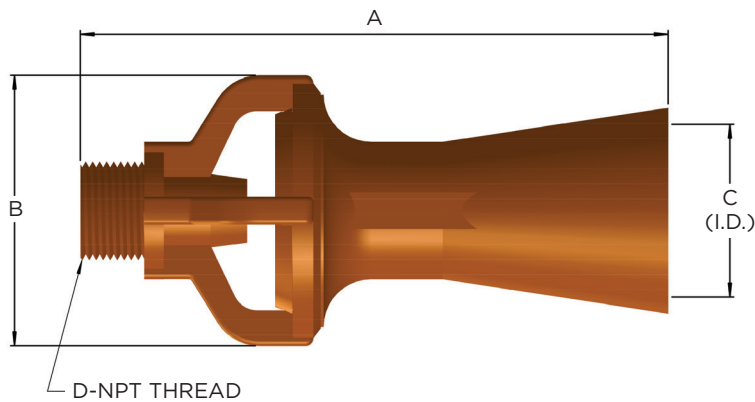

### DIMENSIONS (in mm)

PART NO.	SIZE	A	B	C	D
025 TMEEDU	1/4 BSPT	69.6	32.0	18.0	6.4
038 TMEEDU	3/8 BSPT	114.1	53.6	31.0	9.5
050 TMEEDU	1/2 BSPT	166.6	63.5	37.1	12.7
075 TMEEDU	3/4 BSPT	159.5	74.4	41.4	19.1
100 TMEEDU	1 BSPT	245.9	98.6	55.1	25.4
150 TMEEDU	1 1/2 BSPT	247.1	118.9	65.8	38.1

## TME CAPACITIES

- ◀ The flow rates shown below are based upon water (SG 1.00) as the motive liquid. To adjust the values for liquids with a different specific gravity, use the following formula:

$$[ \sqrt{1 \div \text{SG of actual motive liquid}} ] \times \text{Table Value} = \text{Flow Rate of actual motive liquid}$$

- ◀ The pressure differential ( $\Delta P$ ) shown in the table is the  $\Delta P$  across the TME, not the pump. The  $\Delta P$  equals the motive inlet pressure ( $P_m$ ) minus the discharge pressure ( $P_d$ ).
- ◀ The discharge pressure is the static liquid pressure in the vessel, assuming the vessel is vented to the atmosphere (see formula below). If the vessel is pressurized, the  $P_d$  is that value plus the static liquid pressure.

$$((\text{Liquid Height in metres}) \times \text{SG}) \times 0.43 = P_d$$

- ◀ For mixing applications, one psi of  $\Delta P$  produces 6" of effective discharge plume length.

OPERATING LIQUID FLOW (lpm)	Pressure Differential (bar)					
	0.5	0.7	1	2	3	5
1/4" BSPT	10.28	12.17	14.54	20.56	25.19	32.52
3/8" BSPT	24.52	29.03	34.68	49.04	60.07	77.54
1/2" BSPT	34.55	40.89	48.86	69.08	84.62	109.24
3/4" BSPT	45.62	54.01	64.52	91.23	111.75	144.27
1" BSPT	78.85	93.33	111.51	157.67	193.13	249.33
1 1/2" BSPT	113.39	134.23	160.36	226.76	277.75	358.58

**Note:** The flow rate that is shown in the above chart is the motive or throughput of the eductor. The actual discharge from the eductor is 5 times the motive.

**Example:** 3/8" eductor @ .7 bar = 29.03 discharge; 5 x 29.03 = 145.15 lpm.

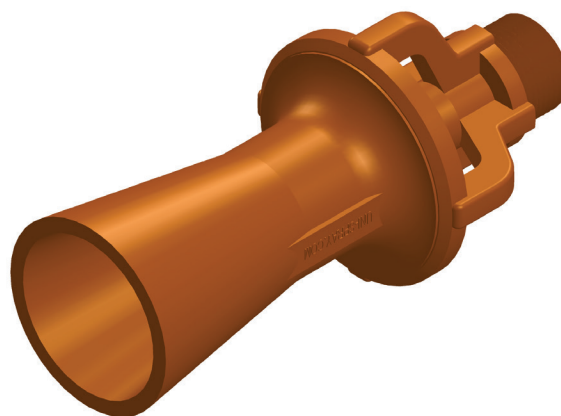

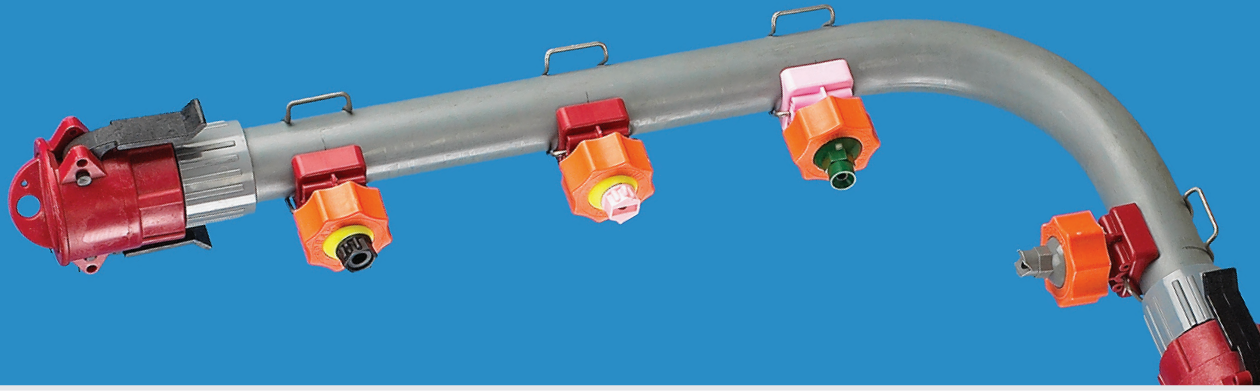

## COMPLETE QUIK-DISCONNECT RISER ASSEMBLIES

- ◀ Direct to you from Uni-Spray, made exactly to your specifications and ready to install.
- ◀ We offer a full range of our own exclusive Quik-Disconnect components in a full range of sizes, including premium-quality PVC, CPVC, PolyPro, Kynar and stainless steel pipe.
- ◀ To give you total design flexibility, we can custom bend the pipework, providing smooth flow without extra fittings, to precisely meet your design configuration.
- ◀ To simplify your ordering process, we offer over 20 design configurations with separate worksheets for each. The worksheets allow you to enter all of the dimensions, design parameters, selection and positioning of components in a simple, fill-in-the-blank format.
- ◀ If you don't see exactly what you want, send us your own drawing for a quotation.
- ◀ When we receive your completed worksheet or drawing, our engineers will review it for accuracy, and we will provide with a detailed quote.

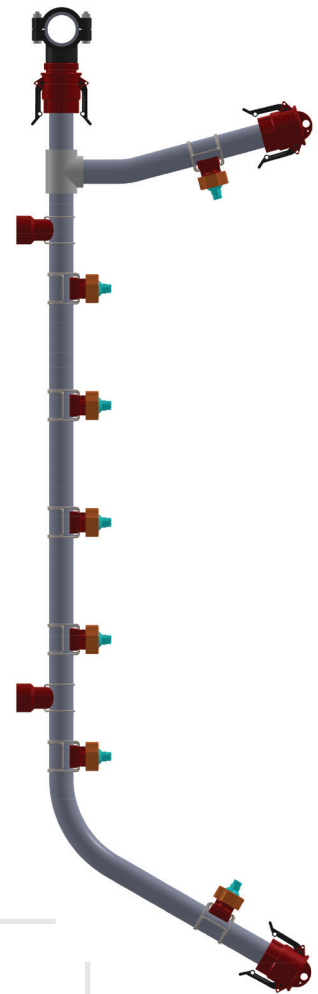

*Exclusive to Uni-Spray, our formed risers eliminate the need for expensive glued couplers. In addition, smooth bends increase fluid flow and prevent material buildup.*

## QUIK-DISCONNECT RISERS - CONTACT US FOR A WORKSHEET

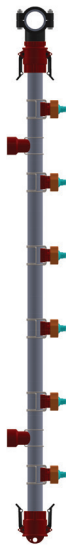

**R1T**

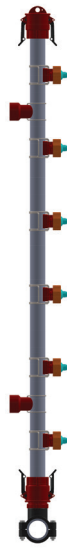

**R1B**



**R2C**

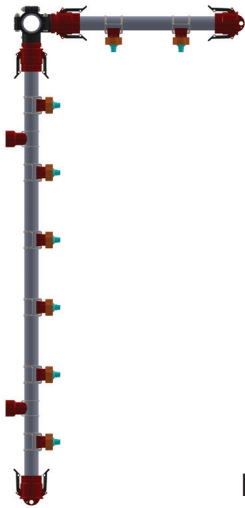

**R3T**

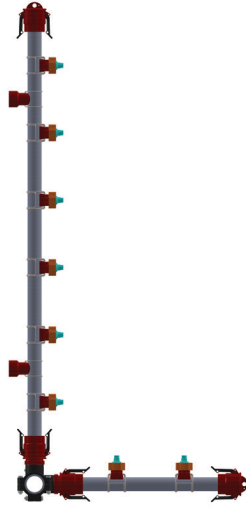

**R3B**

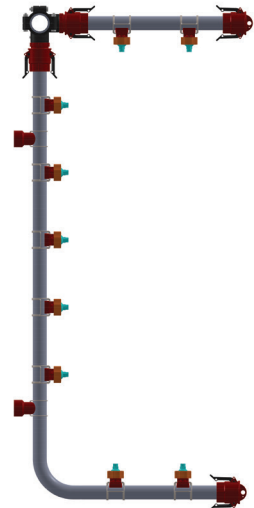

**R4T**

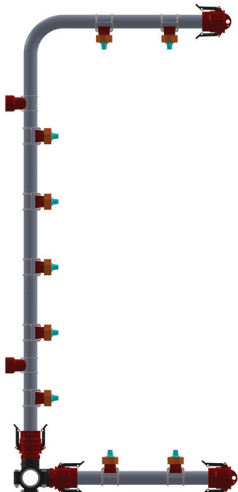

**R4B**

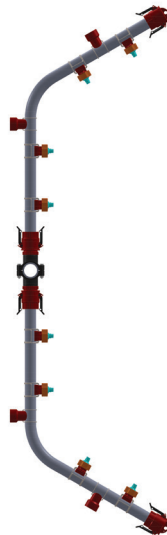

**R5C**

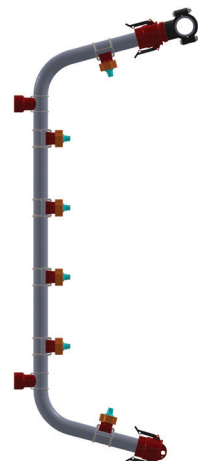

**R6T**

# QUIK-DISCONNECT RISERS - CONTACT US FOR A WORKSHEET

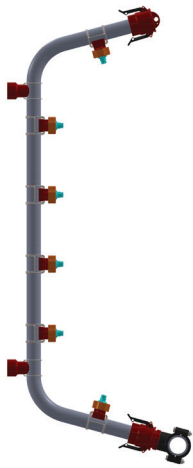

**R6B**

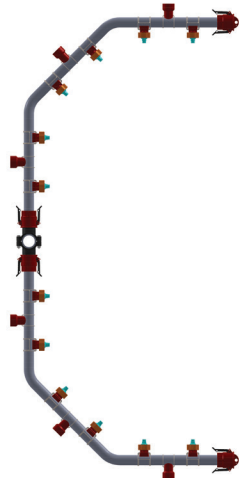

**R7C**

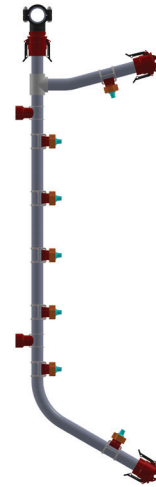

**R8T**

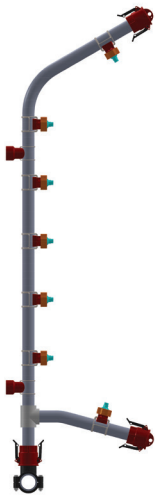

**R8B**

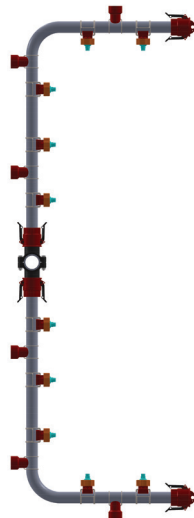

**R9C**

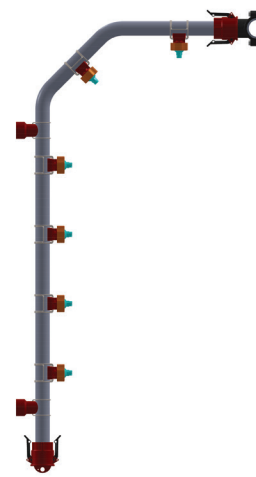

**R10T**

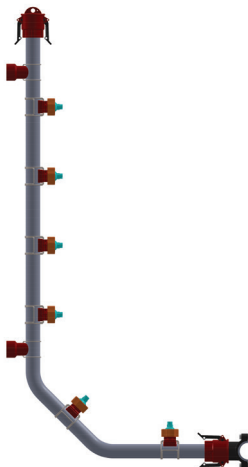

**R10B**

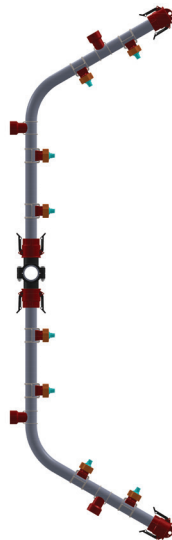

**R5C**

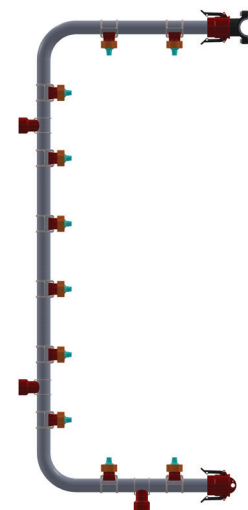

**R11T**

SEE WORKSHEET SAMPLE, PAGE 39

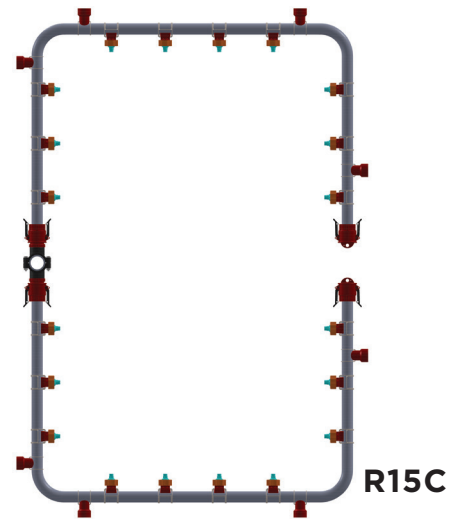
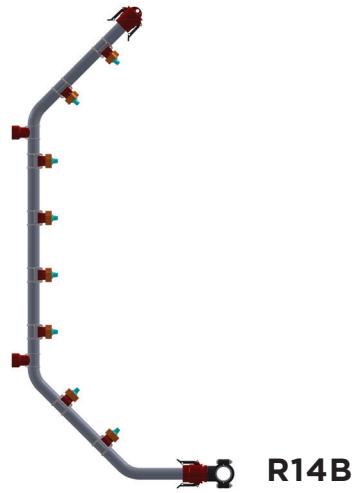
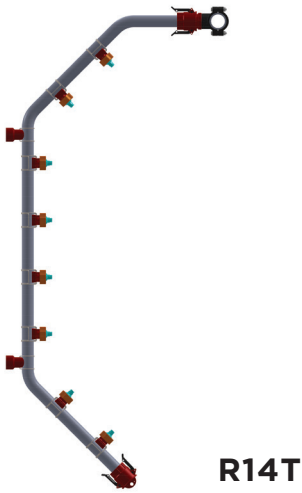
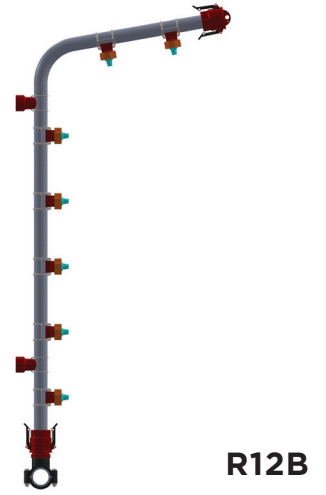
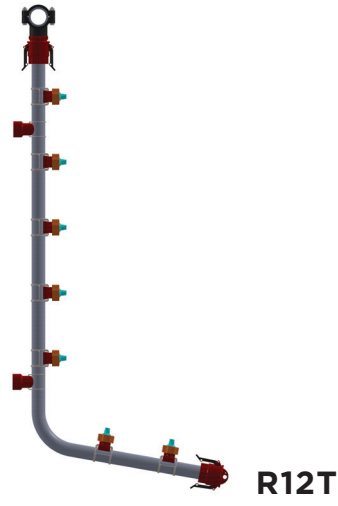
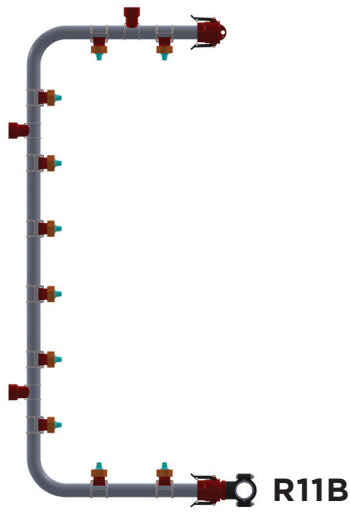



## REQUEST A QUOTE ON A UNI-SPRAY CUSTOM-DESIGNED RISER TO FIT YOUR APPLICATION!

**UNI-SPRAY SYSTEMS INC.**

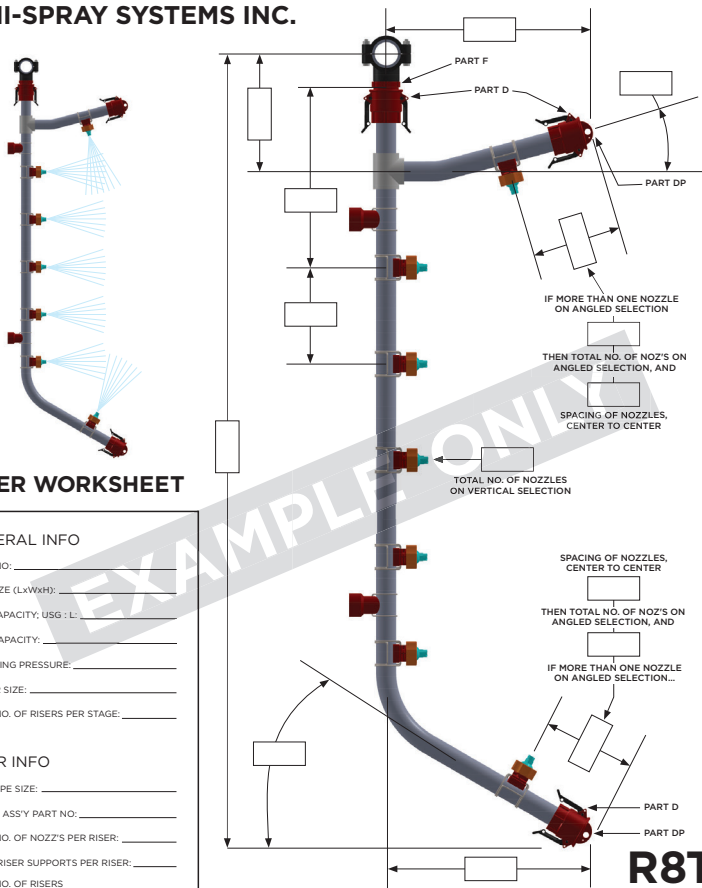

**RISER WORKSHEET**

**GENERAL INFO**

STAGE NO: \_\_\_\_\_

TANK SIZE (LxWxH): \_\_\_\_\_

TANK CAPACITY, USG : L: \_\_\_\_\_

PUMP CAPACITY: \_\_\_\_\_

OPERATING PRESSURE: \_\_\_\_\_

HEADER SIZE: \_\_\_\_\_

TOTAL NO. OF RISERS PER STAGE: \_\_\_\_\_

**RISER INFO**

RISER PIPE SIZE: \_\_\_\_\_

NOZZLE ASS'Y PART NO: \_\_\_\_\_

TOTAL NO. OF NOZZ'S PER RISER: \_\_\_\_\_

NO. OF RISER SUPPORTS PER RISER: \_\_\_\_\_

TOTAL NO. OF RISERS OF THIS TYPE FOR THIS ORDER INCLUDING SPARES: \_\_\_\_\_

DATE (M,D,Y): \_\_\_\_\_

NOTES: \_\_\_\_\_

\_\_\_\_\_

\_\_\_\_\_

\_\_\_\_\_

CUSTOMER: \_\_\_\_\_

ADDRESS: \_\_\_\_\_

CONTACT: \_\_\_\_\_

PHONE: \_\_\_\_\_

FAX: \_\_\_\_\_

**UNI-SPRAY SYSTEMS INC.**

CORPORATE OFFICE:  
44 Durward Place,  
Waterloo, Ontario, Canada N2L 4E4  
Tel: (519) 885-4270 Fax: (519) 885-4325

### To Assemble

1. Find the Riser closest to your requirements, on pages 35 to 37 of this catalogue.
2. Call Uni-Spray and we will fax or email you the Riser Worksheet for the Riser style you have selected, such as the sample left (shown full-size on page 39).
3. Fill in all the information boxes, and add any other relevant details. Print clearly with a black pen or pencil. See page 40 for important design considerations.
4. Return the Worksheet to us by fax or email. We will prepare a quotation for evaluation.
5. We will produce a drawing or shop-ready Worksheet Copy of your Riser, and return it to you for confirmation.
6. Check the returned drawing for any changes. Contact us if any changes are required.
7. When the drawing is done to your satisfaction, authorize it with your signature and the date, and return it to us by mail or fax along with your Purchase Order number.
8. Uni-Spray will confirm price and delivery.

### ASK OUR EXPERTS

If you have any questions, don't hesitate to call us. Our experts are always ready to help with a special order, even if the Riser style you want is not shown in our current listings.

Tel: +44 (0) 1273 400092

# UNI-SPRAY SYSTEMS INC.

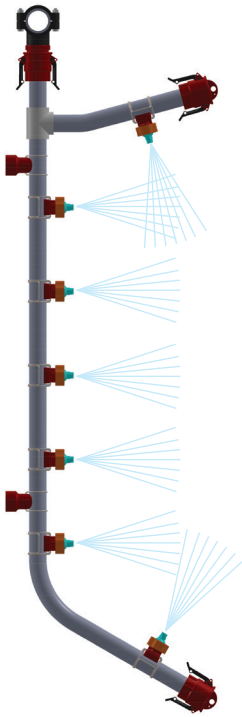

## RISER WORKSHEET

### GENERAL INFO

STAGE NO: \_\_\_\_\_  
 TANK SIZE (LxWxH): \_\_\_\_\_  
 TANK CAPACITY; USG : L: \_\_\_\_\_  
 PUMP CAPACITY: \_\_\_\_\_  
 OPERATING PRESSURE: \_\_\_\_\_  
 HEADER SIZE: \_\_\_\_\_  
 TOTAL NO. OF RISERS PER STAGE: \_\_\_\_\_

### RISER INFO

RISER PIPE SIZE: \_\_\_\_\_  
 NOZZLE ASS'Y PART NO: \_\_\_\_\_  
 TOTAL NO. OF NOZZ'S PER RISER: \_\_\_\_\_  
 NO. OF RISER SUPPORTS PER RISER: \_\_\_\_\_  
 TOTAL NO. OF RISERS OF THIS TYPE FOR THIS ORDER INCLUDING SPARES: \_\_\_\_\_

DATE (M,D,Y): \_\_\_\_\_

NOTES: \_\_\_\_\_  
 \_\_\_\_\_  
 \_\_\_\_\_  
 \_\_\_\_\_

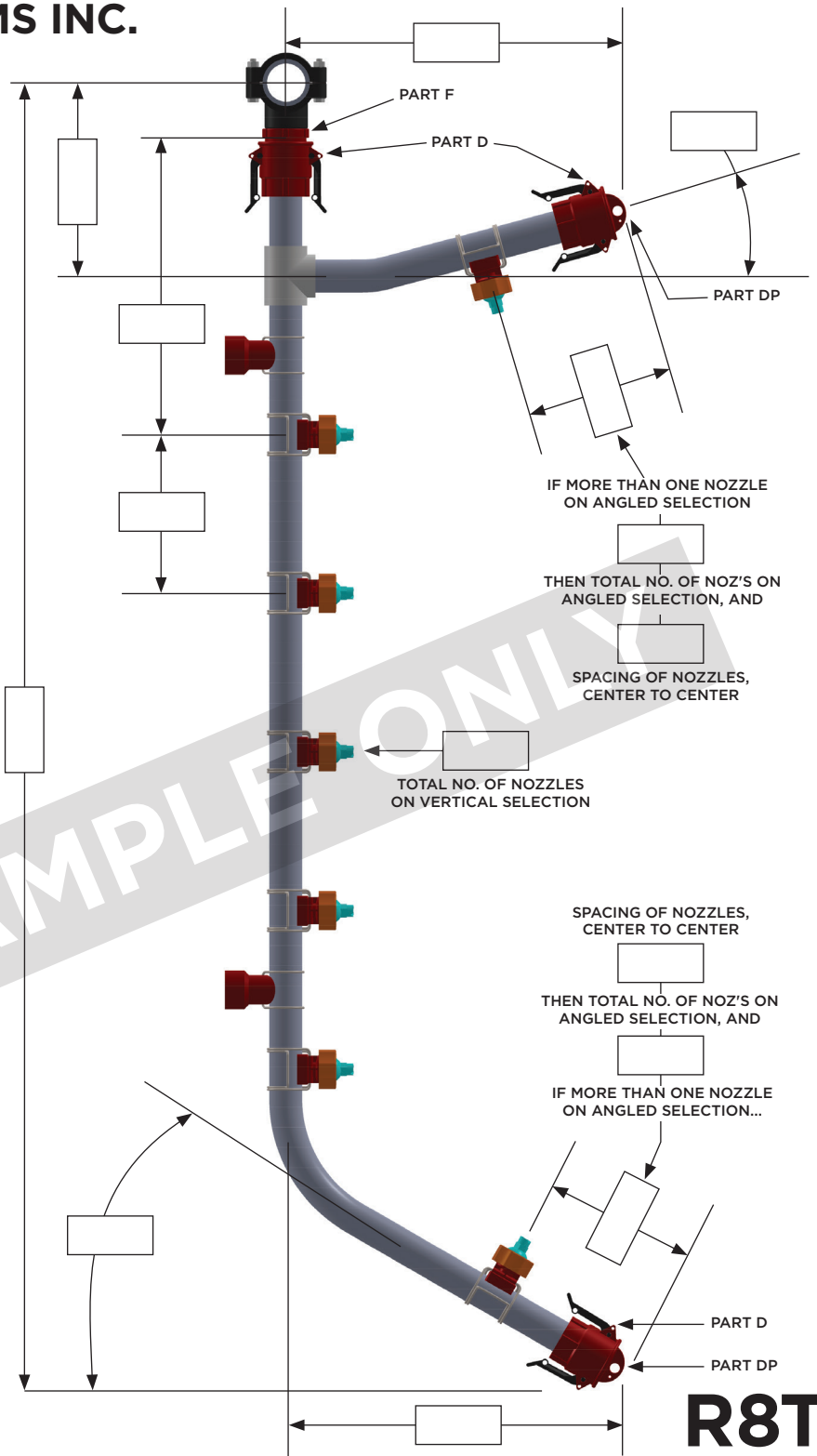

# R8T

CUSTOMER: \_\_\_\_\_

ADDRESS: \_\_\_\_\_

CONTACT: \_\_\_\_\_

PHONE: \_\_\_\_\_

FAX: \_\_\_\_\_

### UNI-SPRAY SYSTEMS INC.

CORPORATE OFFICE:  
 44 Durward Place,  
 Waterloo, Ontario, Canada N2L 4E4  
 Tel: (519) 885-4270 Fax: (519) 885-4325

# SPRAY ANGLE SELECTION AND SPACING

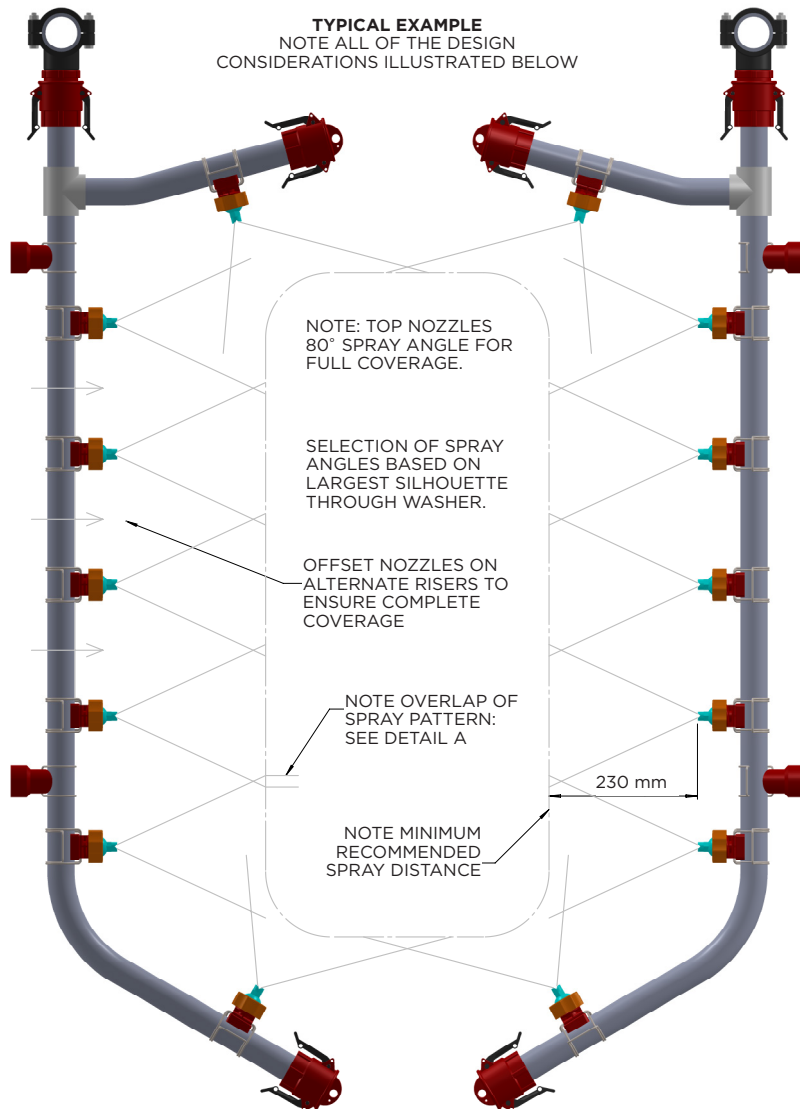

**PLEASE NOTE**

When selecting Nozzle Spray Angle, and the quantity and distance between nozzles, it is necessary to consider the size and shape of the largest ware that will pass through the washer.

Nozzles must be sized and spaced so that their sprays will cover the entire part, with at least 25 mm overlap between adjacent spray patterns. Sprays should be at least 230 mm from the end of the tip to the part for even coating. The nozzles should be rotated 15° from the Riser axis to avoid interference from overlap spray patterns.

**Failure to observe the guidelines may result in poor coating weights and banding.**

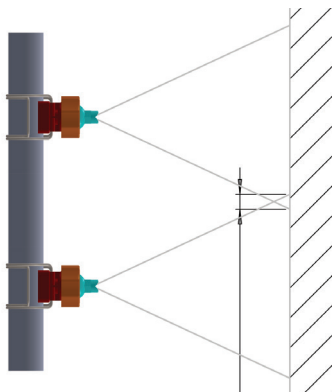
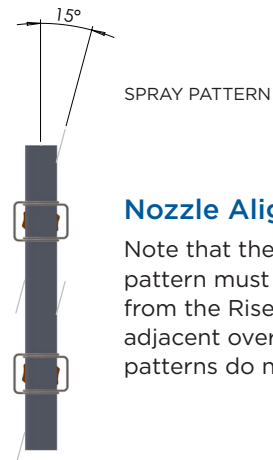

OVERLAP: CORRECT

### Detail A: Nozzle Spacing

Select Nozzle Spray Angles and Nozzle Spacing on the Riser so that there is at least a 25 mm overlap between adjacent sprays, as shown at left. This measurement must be obtained using the largest silhouette which must pass through the washer.

Incorrect Spray Angle selection and Nozzle Spacing as shown at right can result in banding.

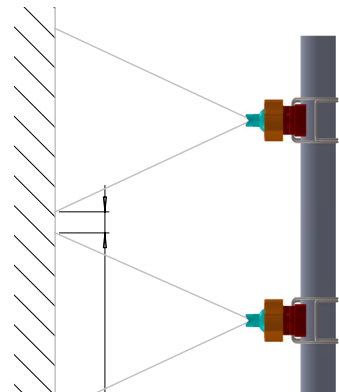

GAP: INCORRECT



# Uni-Spray Systems Inc.



THE  
**SPRAY NOZZLE**  
 PEOPLE

## The Spray Nozzle People

Caveridge Farm  
 Caveridge Lane  
 South Chailey  
 United Kingdom  
 BN8 4BA  
 Telephone: 01273 400092  
 Website: [www.spray-nozzle.co.uk](http://www.spray-nozzle.co.uk)  
 Email: [info@spray-nozzle.co.uk](mailto:info@spray-nozzle.co.uk)